



ORIENT

Photo coupler

Product Data Sheet

Part Number: OR-4N2X_OR-4N3X

Customer: _____

Date: _____

SHENZHEN ORIENT COMPONENTS CO., LTD

Block A3rd Floor No.4 Building, Tian'an Cyber Park, Huangge Rd, LongGang Dist, Shenzhen, GD

TEL: 0755-29681816

FAX: 0755-29681200

www.orient-opto.com

1. Features

- (1) 4N2X series: 4N25, 4N26, 4N27, 4N28; 4N3X series: 4N35, 4N36, 4N37, 4N38
- (2) High isolation voltage between input and output (Viso=5000 V rms)
- (3) Creepage distance >7.62 mm
- (4) Operating temperature up to +115°C
- (5) Compact dual-in-line package
- (6) ESD pass HBM 8000V/MM 2000V
- (7) Safety approval

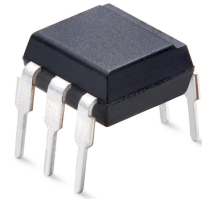

UL approved(No.E323844)

VDE approved(No.40029733)

CQC approved (No.CQC19001231480)

- (8) In compliance with RoHS, REACH standards.
- (9) MSL Class I

2. Instructions

The 4N2X, 4N3X, series of devices each consist of an infrared emitting diode optically coupled to a photo transistor. They are packaged in a 6-pin DIP package and available in wide-lead spacing and SMD option.

3. Application Range

- (1) Power supply regulators
- (2) Digital logic inputs
- (3) Microprocessor inputs

4. Functional Diagram

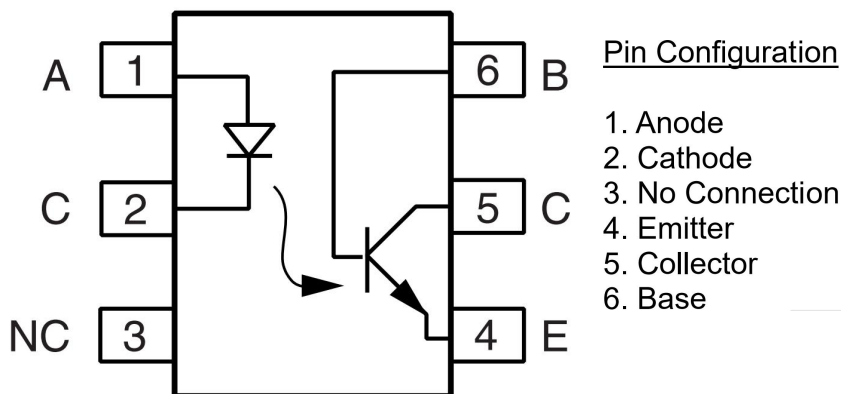

5. Max Absolute rated Value (Normal Temperature=25°C)

	Parameter	Symbol	Rated Value	Unit
Input	Forward Current	I_F	60	mA
	Junction Temperature	T_J	125	°C
	Reverse Voltage	V_R	6	V
	Power dissipation ($T_A = 25^\circ\text{C}$) Derating factor (above 100°C)	P_D	100	mW
			3.8	mW/°C
Output	Collector-emitter Voltage	V_{CEO}	80	V
	Collector-Base voltage	V_{CBO}	80	
	Emitter-Collector voltage	V_{ECO}	7	
	Emitter-Base voltage	V_{EBO}	7	
	Power dissipation ($T_A = 25^\circ\text{C}$) Derating factor (above 100°C)	P_C	150	mW
			9.0	mW/°C
Total Consume Power		P_{tot}	200	mW
*1 Insulation Voltage		V_{iso}	5000	Vrms
Working Temperature		T_{opr}	-55 to + 115	°C
Deposit Temperature		T_{STG}	-55 to + 150	
*2 Soldering Temperature		T_{SOL}	260	

*1. AC Test, 1 minute, humidity = 40~60%

Insulation test method as below:

- (1) Short circuit both terminals of photocoupler.
- (2) No Current when testing insulation voltage.
- (3) Adding sine wave voltage when testing

*2. soldering time is 10 seconds.

6. Opto-electronic Characteristics

Parameter		Symbol	Min	Typ.*	Max	Unit	Condition	
Input	Forward Voltage	V_F	---	1.2	1.5	V	$I_F=10\text{mA}$	
	Reverse Current	I_R	---	---	10	μA	$V_R=6\text{V}$	
	Collector capacitance	C_{in}	---	30	---	pF	$V=0, f=1\text{MHz}$	
Output	Collector-Base dark current		I_{CBO}	---	20	nA	$V_{CB}=10\text{V}$	
	Collector to emitter Current	4N2X	I_{CEO}	---	---	50	nA	$V_{CE}=10\text{V}, I_F=0\text{mA}$
		4N3X		---	---	50		$V_{CE}=60\text{V}, I_F=0\text{mA}$
	Collector-Emitter attenuation Voltage		BV_{CEO}	80	---	---	V	$I_C=1\text{mA}$
	Collector-Base breakdown voltage		BV_{CBO}	80				$I_C=0.1\text{mA}$
	Emitter-Collector attenuation Voltage		BV_{ECO}	7	---	---	V	$I_E=0.1\text{mA}$
	Emitter-Base breakdown voltage		BV_{EBO}	7				$I_E=0.1\text{mA}$
Transforming Characteristics	Current Transfer ratio	4N35, 4N36, 4N37	CTR	100	---	---	%	$I_F=10\text{mA}$ $V_{CE}=10\text{V}$
		4N25, 4N26, 4N38		20	---	---		
		4N27, 4N28		10	---	---		
	Collector and Emitter Saturation Voltage	4N25, 4N26, 4N27, 4N28	$V_{CE(sat)}$	---	---	0.5	V	$I_F=50\text{mA}$ $I_C=2\text{mA}$
		4N35, 4N36, 4N37		---	---	0.3		$I_F=10\text{mA},$ $I_C=0.5\text{mA}$
		4N38		---	---	1.0		$I_F=20\text{mA},$ $I_C=4\text{mA}$
	Isolation resistance		R_{iso}	10^{11}	---	---	Ω	DC500V 40~60%R.H.
	Floating Capacitance		C_f	---	0.2	---	pF	$V=0, f=1\text{MHz}$
	Response Time		t_r	---	3	10	μs	$V_{CC}=10\text{V}, I_C=10\text{mA}$ $R_L=100\Omega$
Descend Time		t_f	---	6	10	μs		

- Current Conversion Ratio = $I_C / I_F \times 100\%$



7. Order Information

Part Number

OR-4NXXU-Y-Z

Note

4NXX = Part Number, 4N25,4N26,4N27,4N28,4N35,4N36,4N37 or 4N38.

U = Lead form option (S, M or None)

Y = Tape and reel option (TA,TA1 or none).

Z = 'V' code for VDE safety (This options is not necessary).

* VDE Code can be selected.

Option	Description	Packing quantity
None	Standard DIP-6	66 units per tube
M	Wide lead bend (0.4 inch spacing)	66 units per tube
S(TA)	Surface mount lead form (low profile) + TA tape & reel option	1000 units per reel
S(TA1)	Surface mount lead form (low profile) + TA1 tape & reel option	1000 units per reel

8. Naming Rule

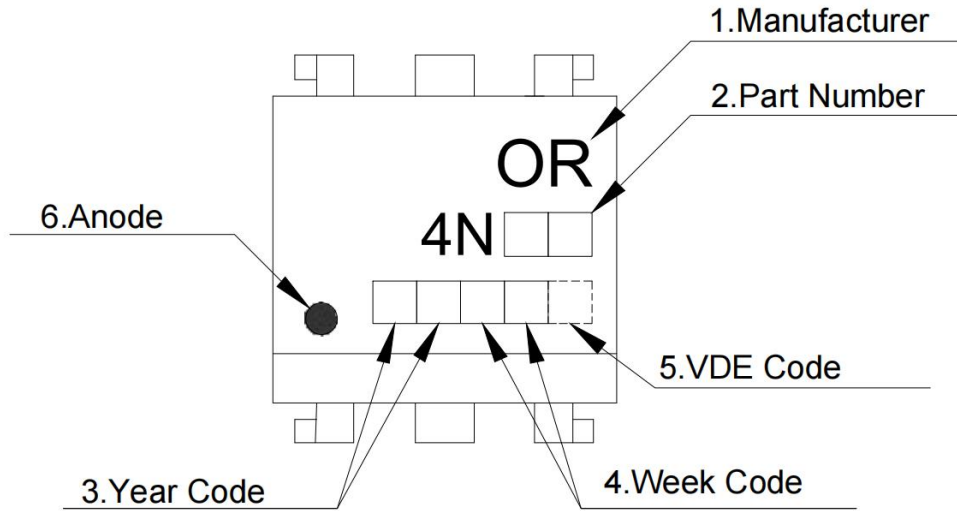

1. Manufacturer : ORIENT.

2. Part Number : 4N25,4N26,4N27,4N28,4N35,4N36,4N37 or 4N38.

3. Year Code : '21' means '2021' and so on.

4. Week Code : 01 means the first week, 02 means the second week and so on.

5. VDE Code . (Optional)

6. Anode.

9. Outer Dimension

(1) OR-4NXX

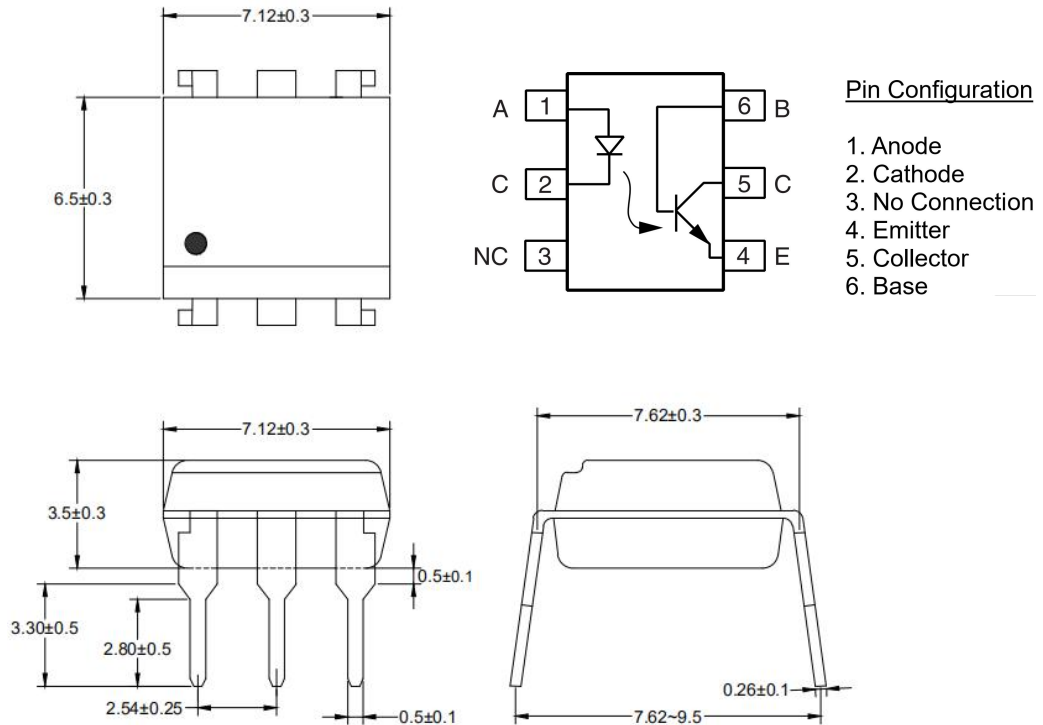

(2) OR-4NXXM

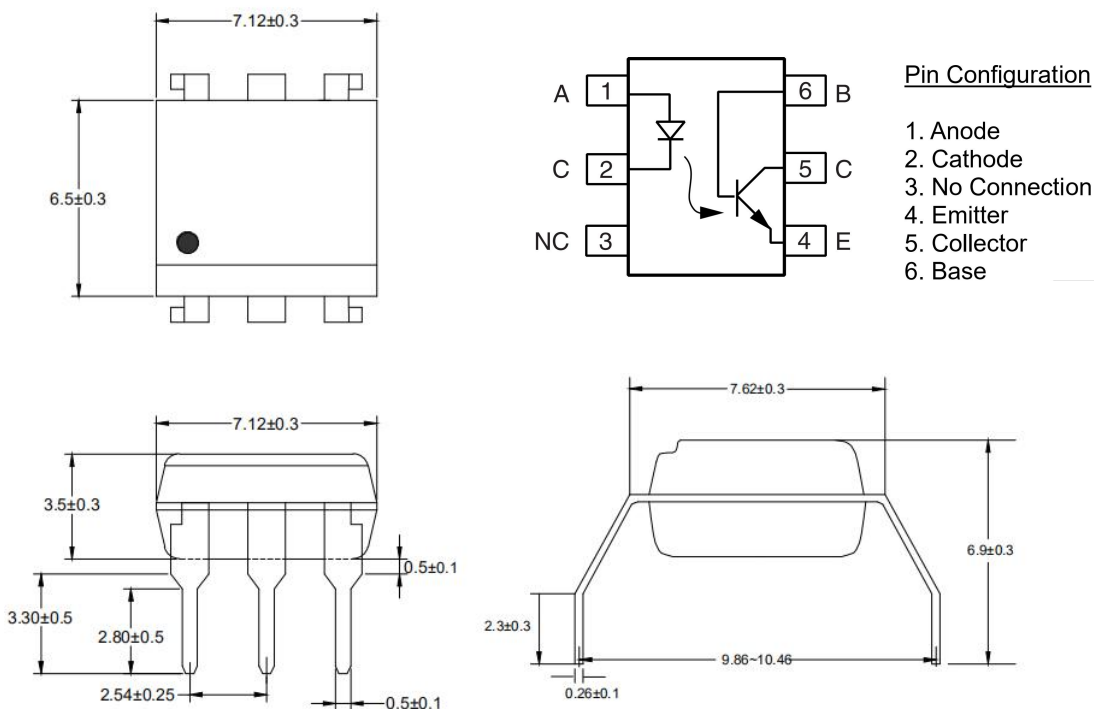

(3) OR-4NXXS

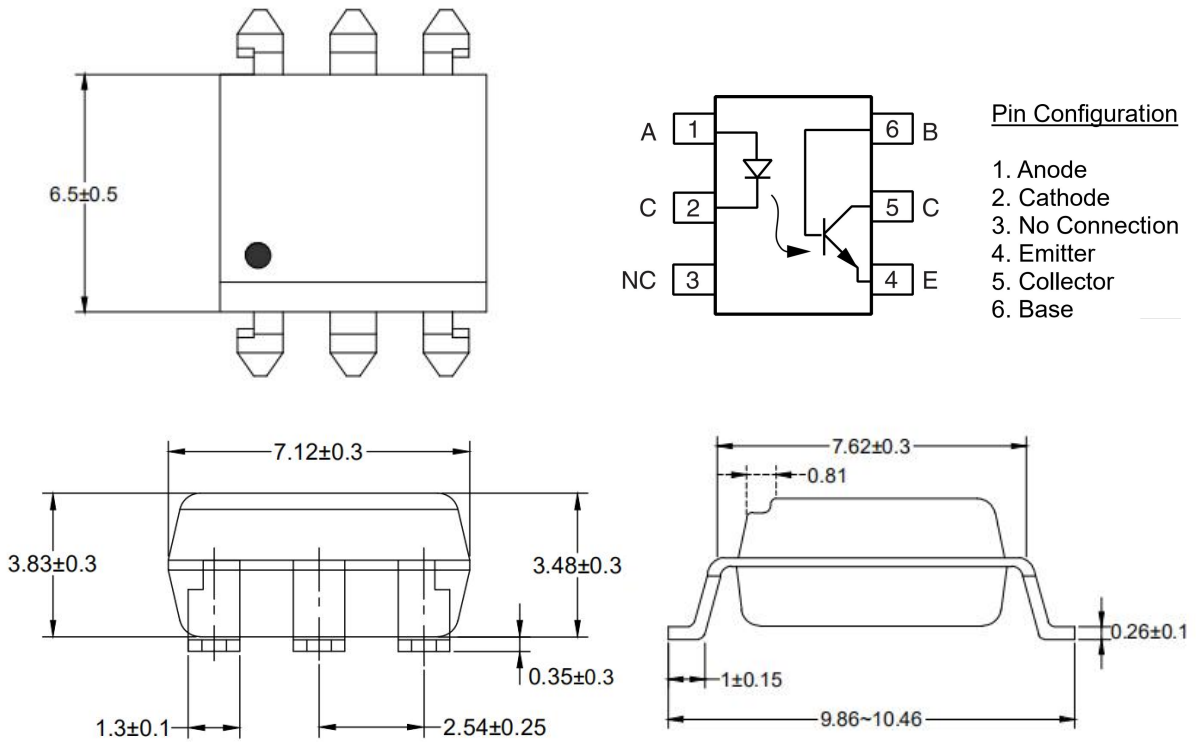

10. Recommended Foot Print Patterns (Mount Pad)

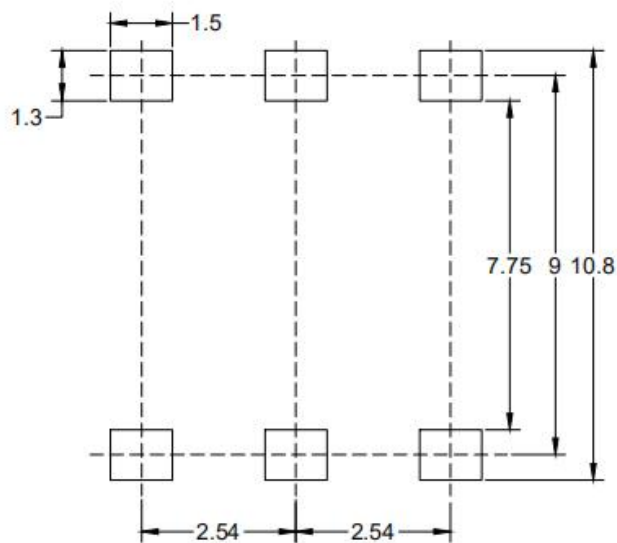

unit: mm

11. Taping Dimensions

(1) OR-4NXXS-TA

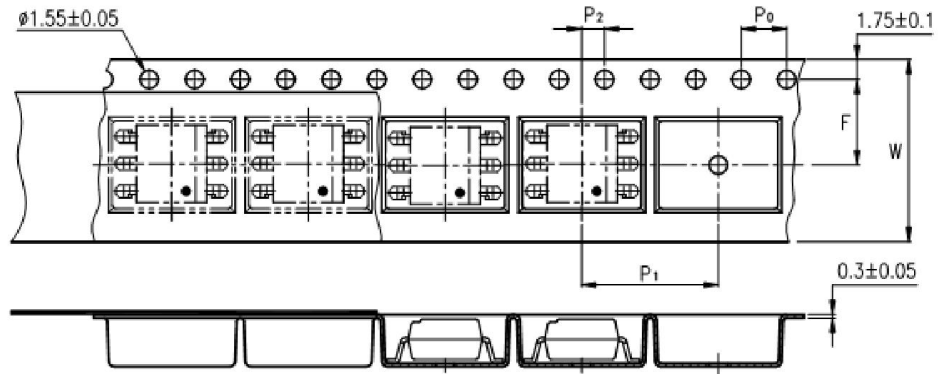

(2) OR-4NXXS-TA1

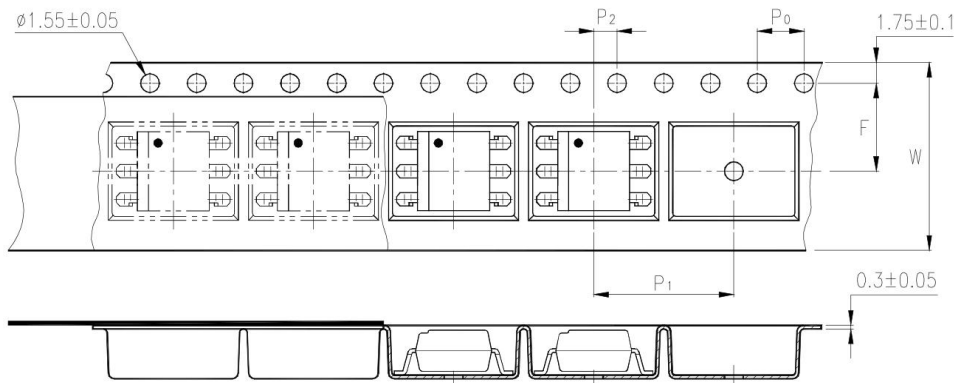

Description	Symbol	Dimension in mm(inch)
Tape wide	W	16±0.3 (0.63)
Pitch of sprocket holes	P0	4±0.1 (0.15)
Distance of compartment	F	7.5±0.1 (0.295)
	P2	2±0.1 (0.079)
Distance of compartment to compartment	P1	12±0.1 (0.472)

Package Type	TA/TA1
Quantities(pcs)	1000

12. Package Dimension

(1) package dimension







DIP/M type

Packing Information	
Packing type	Tube
Qty per Tube	66pcs
Small box (Inner) Dimension	525*128*60mm
Large box (Outer) Dimension	545*290*335mm
The Amount per Inner Box	3,300pcs
The Amount per Outer Box	33,000pcs

SOP type

Packing Information	
Packing type	Reel type
Tape Width	16mm
Qty per Reel	1,000pcs
Small box (inner) Dimension	345*345*58.5mm
Large box (Outer) Dimension	620x360x360mm
Max qty per small box	2,000pcs
Max qty per large box	20,000pcs

(2)Packing Label Sample

 <p>Material Code : 120PCXXXXXX  P/N: OR-XXXXXX  Lot No. : XXXXXX-XXXX-TX-X  D/C: XXXX  Qty: XXXX PCS </p>	  
<div style="display: flex; justify-content: space-around;"> <div style="border: 1px solid black; width: 80px; height: 60px; text-align: center; line-height: 60px;">内箱码</div> <div style="border: 1px solid black; width: 80px; height: 60px; text-align: center; line-height: 60px;">外箱码</div> </div>	
<p>“XXXXXXXXXXXXXXXXXX” (一体机序列码) Made in China</p>	

Note:

1. Material Code :Product ID.
2. P/N :Contents with "Order Information" in the specification.
3. Lot No. :Product data.
4. D/C :Product weeks.
5. Quantity :Packaging quantity.

13. Reliability Test

NO.	ITEMS	Reliability Testing				
		QTY (Pcs)	Condition	Process	Device	Standard
1	RSH 耐焊接热	22	260±5℃	10s/3 次	锡炉	JESD22-A106
2	HTSL 高温存储	77	125℃	168 hrs	高温烤箱 测试仪	JESD22-A103
				500 hrs		
				1000 hrs		
3	LTSL 低温存储	77	-55℃	168 hrs	低温箱 测试仪	JESD22-A119
				500 hrs		
				1000 hrs		
4	TC 温度循环	77	H:125℃ 15min ∫ 5min L:-55℃ 15min	300 cycle	冷热冲击 机	JESD22-A104
5	TS 温度冲击	77	H:100℃ 5min ∫ 15s L:-40℃ 5min	300 cycle	冷热冲击 机	JESD22-A106
6	HTOL 高温操作	77	110℃ IF=10mA Vce=5V	168 hrs	高温烤箱 测试仪、老 化电路板	JESD22-A108
				500 hrs		
				1000 hrs		
7	ESD-HBM 人体模式	22	≥8KV 1Cycle	1 次	ESD 静电测 试仪	JESD22-A114
8	SD 可焊性	22	Pb-free 245±5℃	5S/1 次	锡炉	JESD22-B102
9	HTRB 高温反向偏压	77	HTRB @125℃ Vce=80v	168 hrs	高温烤箱 , 测试仪	JESD22-A103
				500 hrs		
				1000 hrs		
10	H3TRB 温湿度反向偏 压, 寿命试验	77	H3TRB 85℃,85%RH Vce=80v	168 hrs	恒温恒湿机, 测试仪	JESD22-A101
				500 hrs		
				1000 hrs		
11	Autoclave 压力锅	77	Ta=121 ℃,100%RH,2atm	96hrs	压力锅	JESD22-A102

14. Temperature Profile Of Soldering

(1) IR Reflow soldering (JEDEC-STD-020C compliant)

One time soldering reflow is recommended within the condition of temperature and time profile shown below. Do not solder more than three times.

Profile item	Conditions
Preheat	
- Temperature Min (T Smin)	150°C
- Temperature Max (T Smax)	200°C
- Time (min to max) (ts)	90±30 sec
Soldering zone	
- Temperature (TL)	217°C
- Time (t L)	60 sec
Peak Temperature	260°C
Peak Temperature time	20 sec
Ramp-up rate	3°C / sec max.
Ramp-down rate from peak temperature	3~6°C / sec
Reflow times	≤3

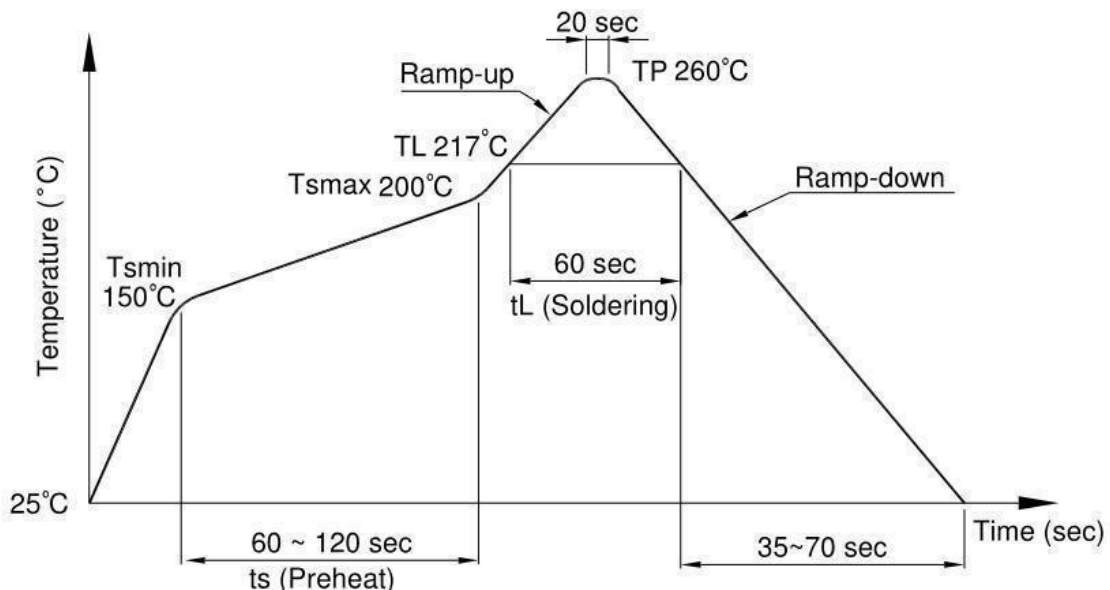

(2) Wave soldering (JEDEC22A111 compliant)

One time soldering is recommended within the condition of temperature.

Temperature	260+0/-5°C
Time	10 sec
Preheat temperature	25 to 140°C
Preheat time	30 to 80 sec

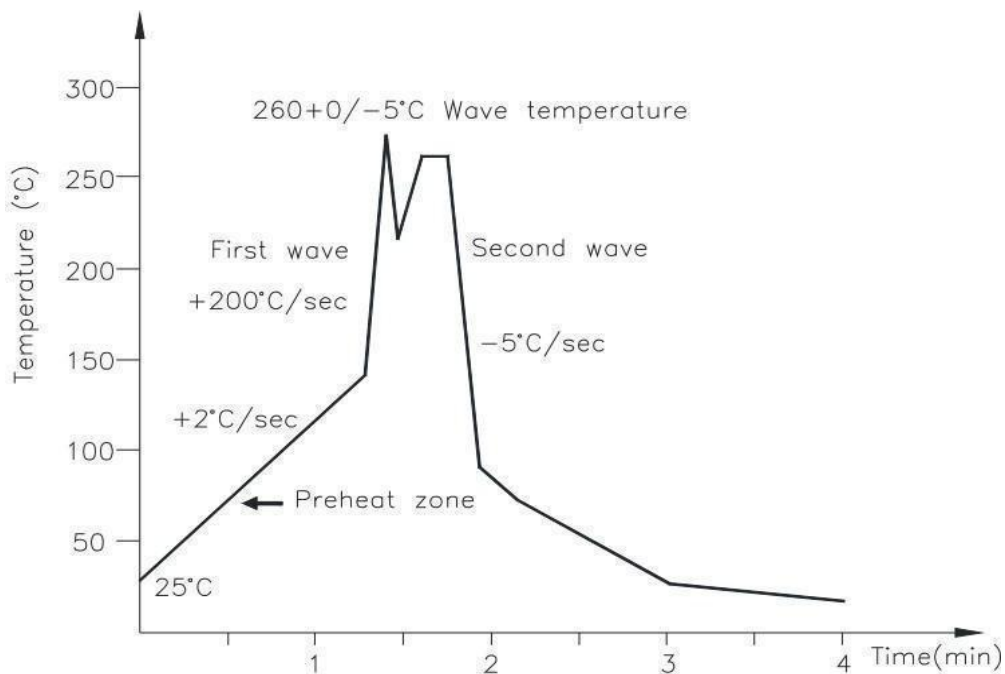

(3) Hand soldering by soldering iron

Allow single lead soldering in every single process. One time soldering is recommended.

Temperature	380+0/-5°C
Time	3 sec max

15. Characteristics Curve

Figure 1. Forward Current vs Forward Voltage

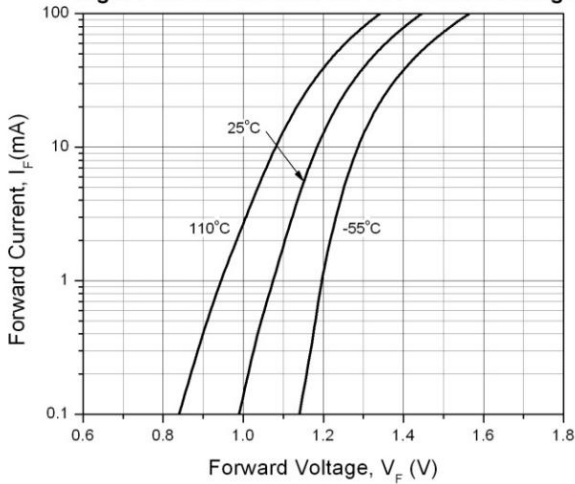

Figure 2. Current Transfer Ratio vs Forward Current

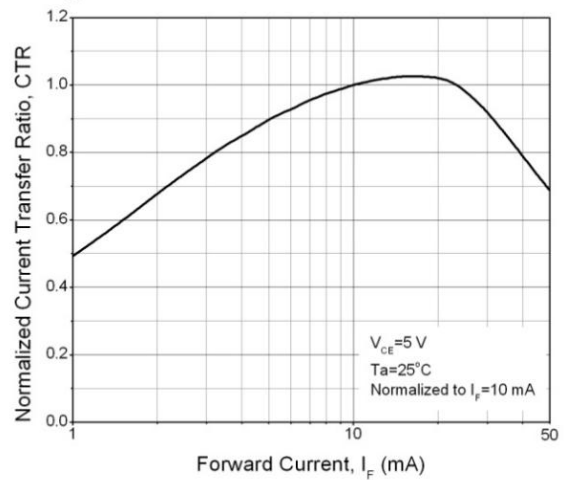

Figure 3. Current Transfer Ratio vs Ambient Temperature

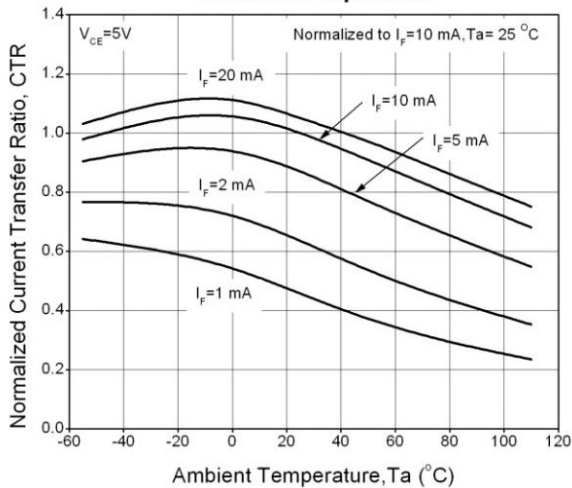

Figure 4. Current Transfer Ratio (Saturated) vs Base-Emitter Resistance

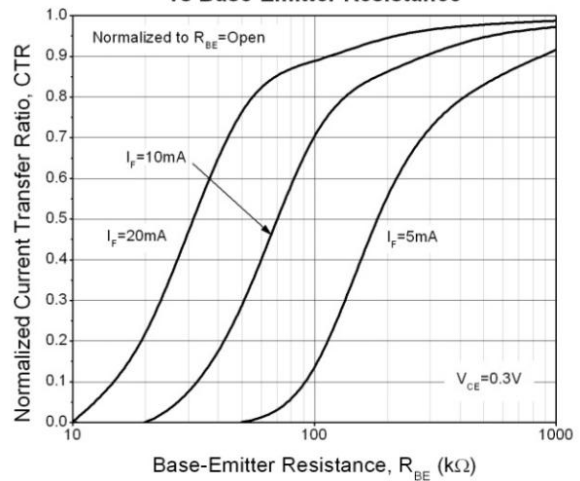

Figure 5. Current Transfer Ratio (Unsaturated) vs Base-Emitter Resistance

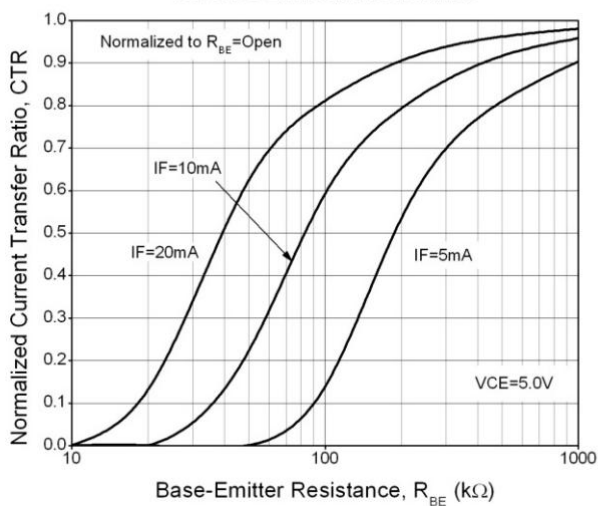

Figure 6. Dark Current vs Ambient Temperature

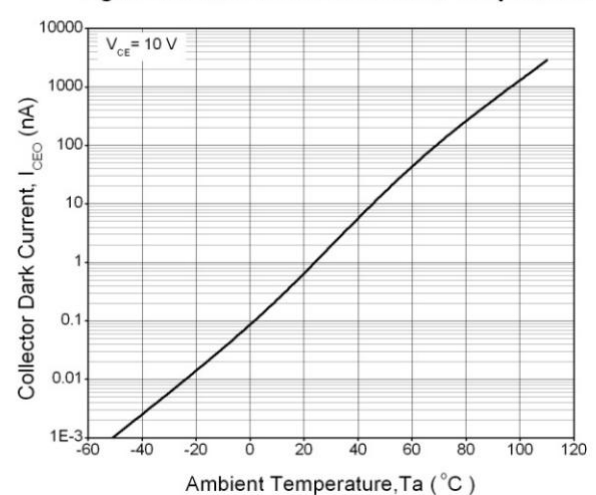

Figure 7. Collector-Emitter Saturation Voltage vs Collector Current

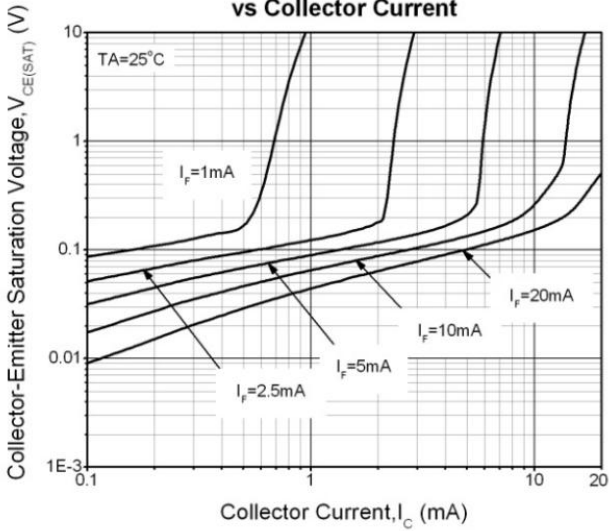

Figure 8. Switching Time vs Load Resistance

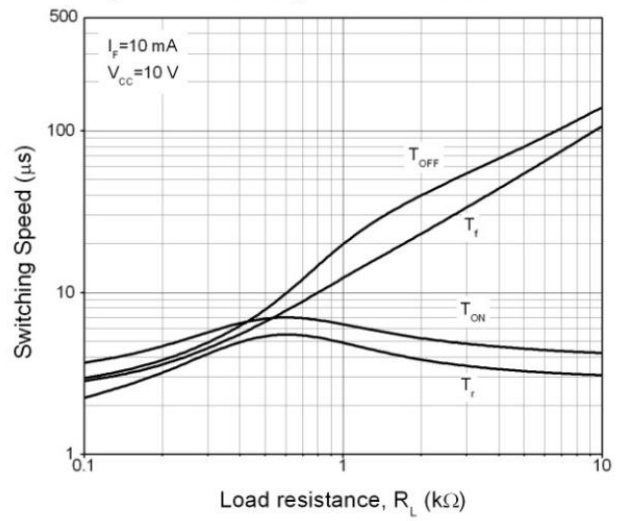

Figure 9. Turn-on Time vs Base-Emitter Resistance

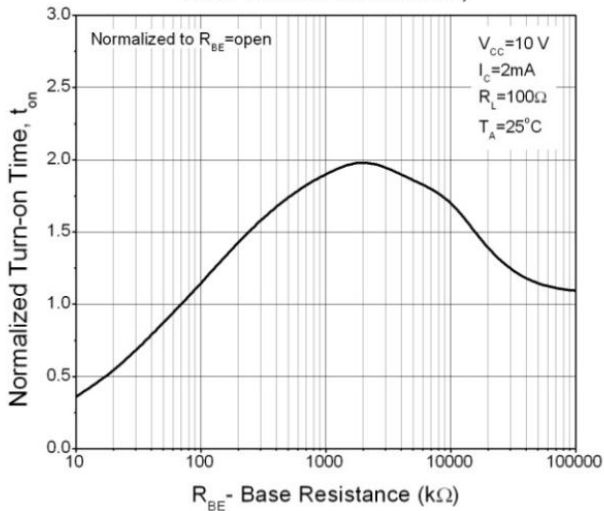

Figure 10. Turn-off Time vs Base-Emitter Resistance

