



ORIENT

Photo coupler

Product Data Sheet

Part Number: OR-T304X/306X/308X

Customer: _____

Date: _____

SHENZHEN ORIENT COMPONENTS CO., LTD

Block A 3rd Floor No.4 Building, Tian'an Cyber Park, Huangge Rd, LongGang Dist, Shenzhen, GD

TEL: 0755-29681816

FAX: 0755-29681200

www.orient-opto.com

1. Features

- (1) High isolation voltage between input and output (Viso:5000 V rms)
- (2) 4pin zero-cross optoisolators triac driver output
- (3) High repetitive peak off-state voltage V_{DRM} :
T304X: Min. 400V;T306X: Min. 600V;T308X: Min. 800V
- (4) High critical rate of rise of off-state voltage(dv/dt : TYP. 800V / μ s)
- (5) Dual-in-line package;Wide lead spacing package; Surface mounting package.
- (6) Operating temperature -40 °C to +110 °C
- (7) Safety approval
UL approved (No.E323844)
VDE approved(No.40029733)
CQC approved (No.CQC09001029446)
- (8) In compliance with RoHS, REACH standards
- (9) MSL Class I



2. Description

The OR-T304X/OR-T306X/OR-T308X series of devices each consist of a GaAs infrared emitting diode optically coupled to a monolithic silicon zero voltage crossing photo triac.They are designed for use with a discrete power triac in the interface of logic systems , such as solid-state relays, industrial controls, motors, solenoids and consumer appliances.

3. Application Range

- (1)AC Motor Drives (2)AC Motor Starters (3)Static power switch (4)Lighting Controls
- (5)Solenoid/Valve Controls (6)Solid State Relays (7)Temperature Controls

4. Absolute Maximum Ratings (Ta=25°C)

| Parameter | | Symbol | Rateing | Unit |
|--------------------------|---|--------------|-------------|------|
| Input | Forward Current | I_F | 50 | mA |
| | Junction Temperature | T_J | 125 | °C |
| | Reverse Voltage | V_R | 6 | V |
| | Power Dissipation | P | 120 | mW |
| Output | Off-State Output Terminal Voltage | OR-T304X | 400 | V |
| | | OR-T306X | 600 | |
| | | OR-T308X | 800 | |
| | Peak Repetitive Surge Current (PW=1ms, 120 pps) | I_{TSM} | 1 | A |
| | On-State RMS Current | $I_{T(RMS)}$ | 100 | mA |
| | Junction Temperature | T_J | 125 | °C |
| | Collector Power Dissipation | P_C | 150 | mW |
| Total Power Dissipation | | P_{tot} | 250 | mW |
| *Insulation Voltage | | V_{iso} | 5000 | Vrms |
| Working Temperature | | T_{opr} | -40 ~ + 110 | °C |
| Deposit Temperature | | T_{stg} | -55 ~ + 125 | |
| *2 Soldering Temperature | | T_{sol} | 260 | |

*1 AC for 1 minute, R.H.= 40 ~ 60% R.H. In this test, pins 1, 2&3 are shorted together, and pins 4, 6 are shorted together.
* 2 For 10 second

5. Electrical Optical Characteristics at Ta=25°C

| Parameter | | Symbol | Min | Typ. | Max | Unit | Condition | | | | |
|-----------|---|-----------------------------------|----------------------------|------------|-----|------------|--------------------------------|-----|-----|---------|---|
| Input | Forward Voltage | V_F | --- | 1.2 | 1.6 | V | $I_F=20mA$ | | | | |
| | Reverse Current | I_R | --- | --- | 5 | μA | $V_R=6V$ | | | | |
| Output | 1.Peak Blocking Current, Either Direction | I_{DRM} | --- | --- | 500 | nA | $V_{DRM} =$ Rated V_{DRM} | | | | |
| | Peak On-State Voltage, Either Direction | V_{TM} | --- | --- | 3.0 | V | $I_{TM}=100mA$ Peak | | | | |
| | 2.Critical rate of Rise of Off-State Voltage | dv/dt | --- | 800 | --- | V/ μs | $V_{in}=240V_{rms}$ | | | | |
| Couple | 3.Led Trigger Current, Current Required to Latch Output, Either Direction | OR-T3040 OR-T3060 OR-T3080 | --- | --- | 30 | mA | Main Terminal Voltage = 3V | | | | |
| | | OR-T3041 OR-T3061 OR-T3081 | --- | --- | 15 | | | | | | |
| | | OR-T3042 OR-T3062 OR-T3082 | I_{FT} | --- | --- | | | 10 | | | |
| | | OR-T3043 OR-T3063 OR-T3083 | --- | --- | 5 | | | | | | |
| | | OR-T3044 OR-T3064 OR-T3084 | --- | --- | 3 | | | | | | |
| | | Holding Current, Either Direction | | I_H | --- | | | 400 | --- | μA | |
| | | ZERO CROSSING | Inhibit Voltage | V_{INH} | --- | | | 5 | 20 | Volts | $I_F = \text{Rated } I_{FT}$, MT1-MT2 Voltage above which device will not trigger. |
| | | | Leakage in Inhibited State | I_{DRM2} | --- | | | --- | 500 | μA | $I_F = \text{Rated } I_{FT}$, Rated V_{DRM} , Off State |



*1. Test voltage must be applied within dv/dt rating.

*2. This is static dv/dt. Commutating dv/dt is a function of the load-driving thyristor(s) only.

*3. All devices are guaranteed to trigger at an I_F value less than or equal to $\max I_{FT}$. Therefore, recommended operating I_F lies between $\max I_{FT}$, 30 mA for OR-T3040, OR-T3060 and OR-T3080, 15 mA for OR-T3041, OR-T3061 and OR-T3081, 10 mA for OR-T3042, OR-T3062 and OR-T3082, 5 mA for OR-T3043, OR-T3063 and OR-T3083, 3 mA for OR-T3044, OR-T3064 and OR-T3084, and absolute $\max I_F$ (50mA).

6. Order Information

Part Number

OR-T304XV-W-Y
or OR-T306XV-W-Y
or OR-T308XV-W-Y

Note

X = IFT Rank (0,1, 2, 3 or 4).

V = Lead form option (S, M or None)。

W = Tape and reel option (TA,TA1 or none).

Y = 'V' code for VDE safety (This options is not necessary).

Z = 'G' code for halogen free (This options is not necessary).

* VDE Code can be selected.

* HF Code can be selected.

| Option | Description | Packing quantity |
|--------|--|---------------------|
| None | Standard DIP-4 | 100 units per tube |
| M | Wide lead bend (0.4 inch spacing) | 100 units per tube |
| S(TP) | Surface mount lead form (low profile) + TP tape & reel option | 2000 units per reel |
| S(TP1) | Surface mount lead form (low profile) + TP1 tape & reel option | 2000 units per reel |

7. Naming Rule

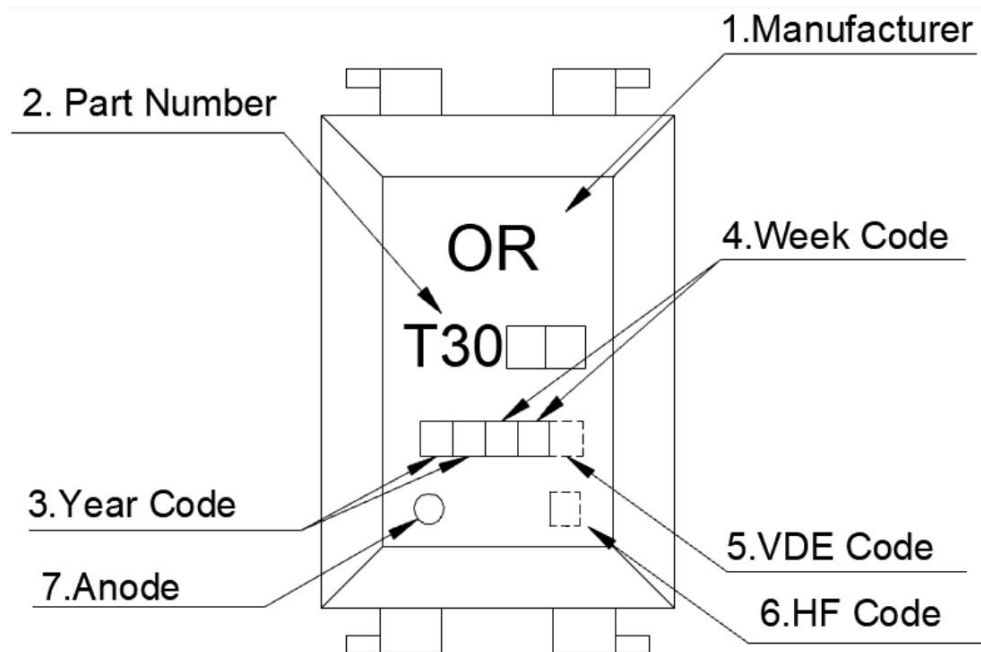

1. Manufacturer : ORIENT.
2. Part Number : T30 .
3. Year Code : '21' means '2021' and so on.
4. Week Code : 01 means the first week, 02 means the second week and so on.
5. VDE Code . (Optional)
6. HF Code . (Optional)
7. Anode.

* VDE Code can be selected.

* HF Code can be selected.

8. Package Dimension

(1).T30XX

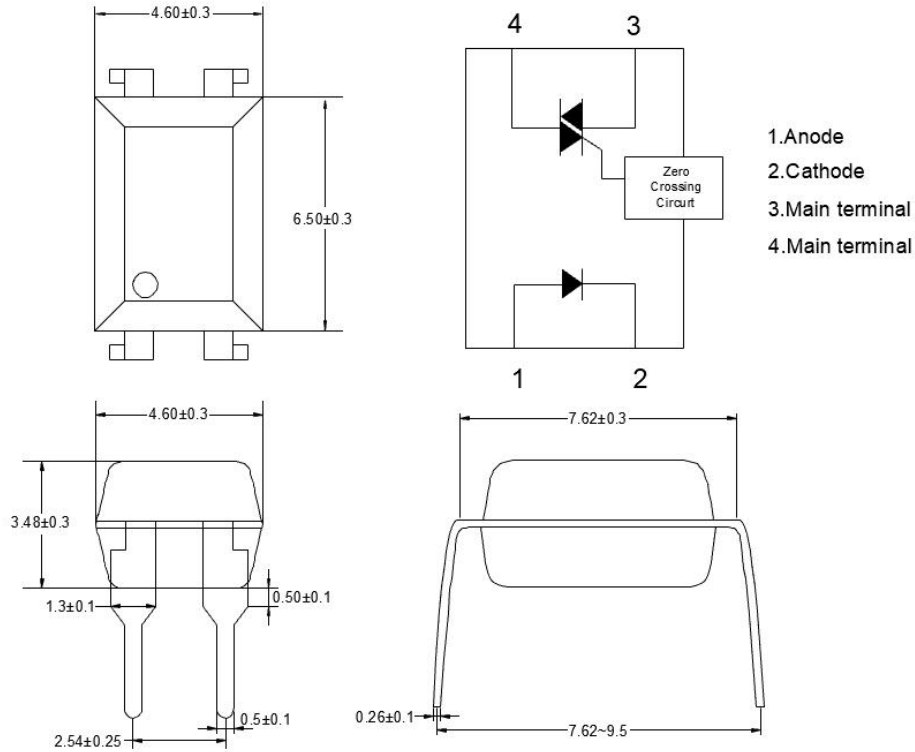

(2).T30XX M

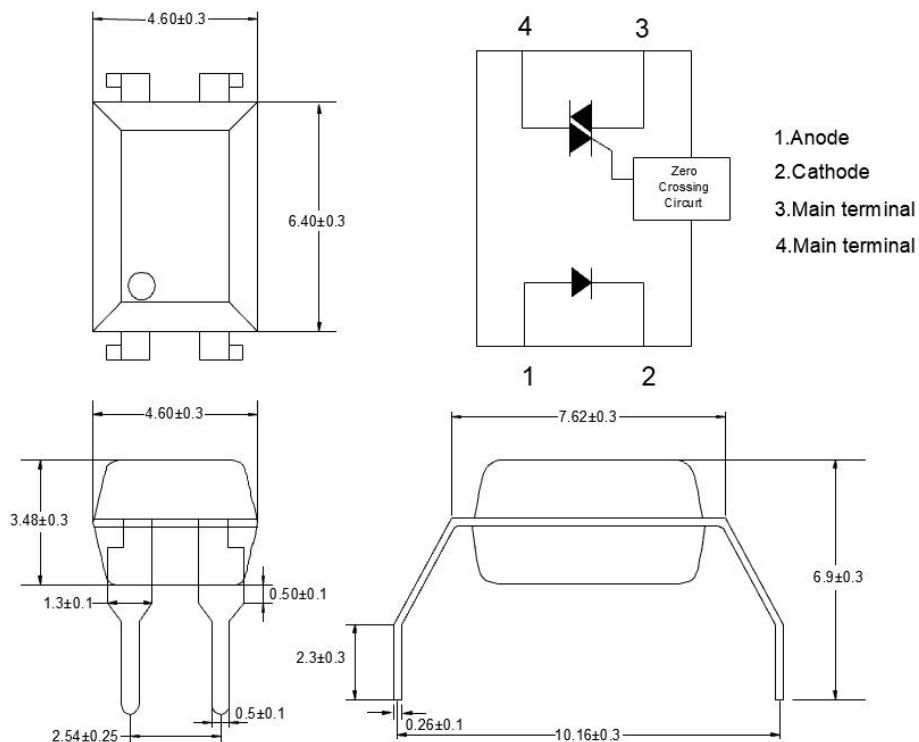

(3).T30XX S

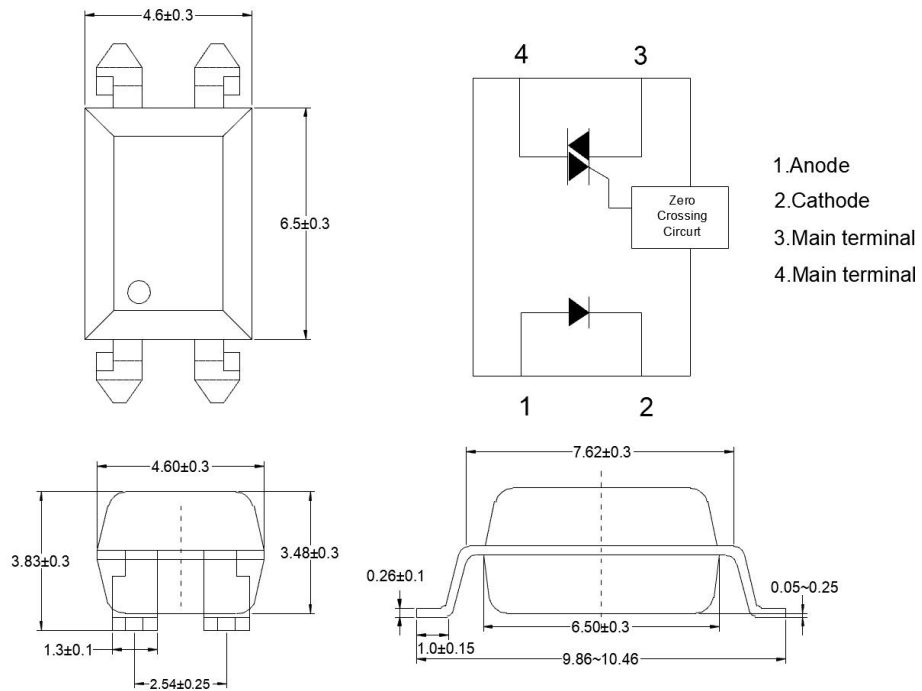

9. Taping Dimensions

(1)OR-T30XXS-TP

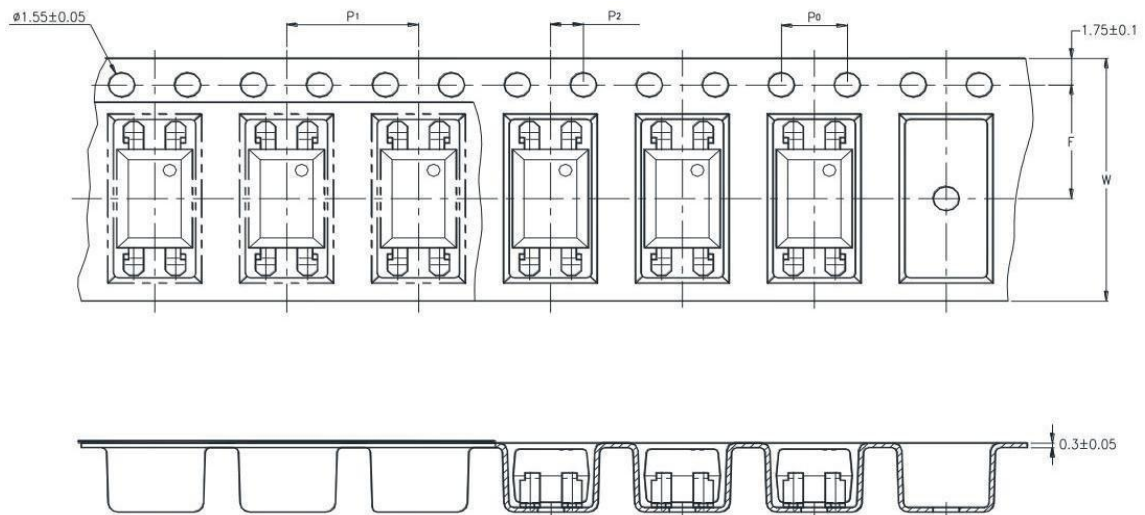

(2)OR-T30XXS-TP1

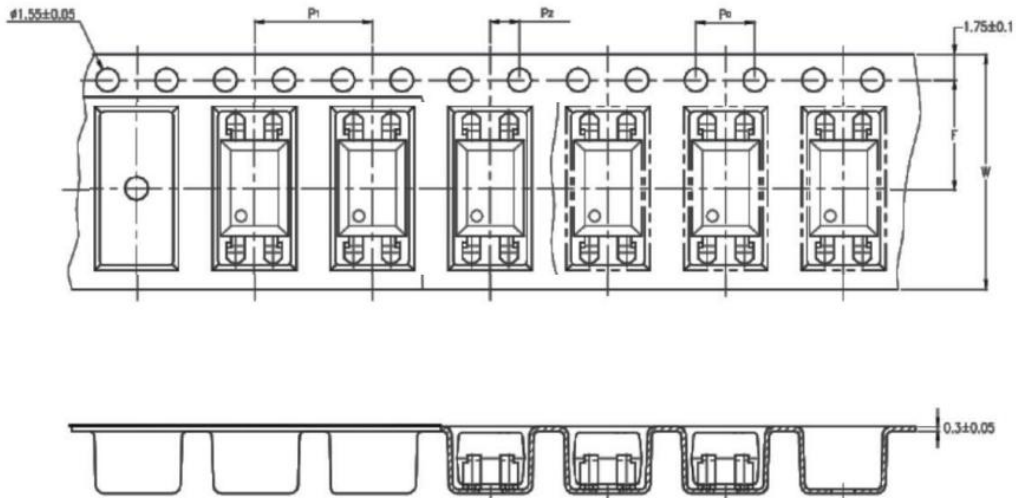

| Description | Symbol | Dimension in mm (inch) |
|--|--------|------------------------|
| Tape wide | W | 16±0.3 (.63) |
| Pitch of sprocket holes | P_0 | 4±0.1 (.15) |
| Distance of compartment | F | 7.5±0.1 (.295) |
| | P_2 | 2±0.1 (.0079) |
| Distance of compartment to compartment | P_1 | 8±0.1 (.472) |

| | |
|-----------------|--------|
| Package Type | TP/TP1 |
| Quantities(pcs) | 2000 |

10. Recommended Foot Print Patterns (Mount Pad) (Unit: mm)

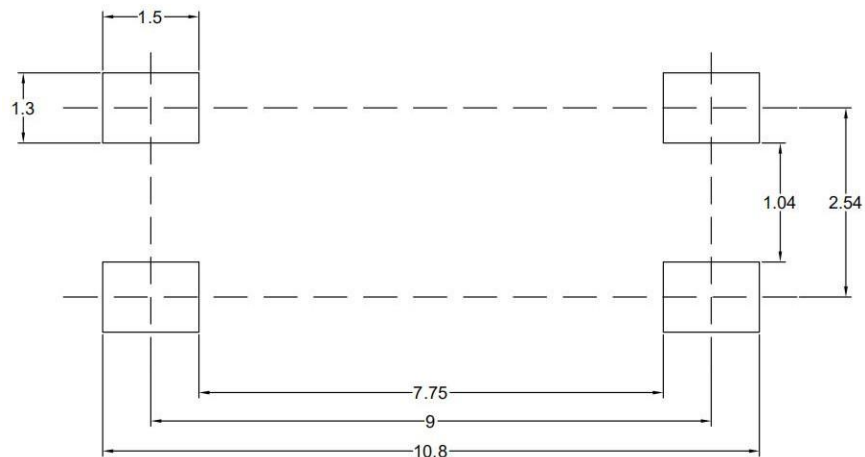

11. Package Dimension

(1) package dimension







DIP Type

| Packing Information | |
|-----------------------------|---------------|
| Packing type | Tube |
| Qty per Tube | 100pcs |
| Small box (Inner) Dimension | 525*128*60mm |
| Large box (Outer) Dimension | 545*290*335mm |
| The Amount per Inner Box | 5,000pcs |
| The Amount per Outer Box | 50,000pcs |

SOP Type

| Packing Information | |
|-----------------------------|----------------|
| Packing type | Reel type |
| Tape Width | 16mm |
| Qty per Reel | 2,000pcs |
| Small box (inner) Dimension | 345*345*58.5mm |
| Large box (Outer) Dimension | 620x360x360mm |
| Max qty per small box | 4,000pcs |
| Max qty per large box | 40,000pcs |

(2)Packing Label Sample

| | |
|--|---|
|  <p>Material Code : 120PCXXXXXX  P/N : OR-XXXXXX  Lot No. : XXXXXX-XXXX-TX-X  D/C : XXXX  Qty : XXXX PCS </p> |    |
| <div style="display: flex; justify-content: space-around;"> <div style="border: 1px solid black; width: 80px; height: 80px; text-align: center; line-height: 80px;">内箱码</div> <div style="border: 1px solid black; width: 80px; height: 80px; text-align: center; line-height: 80px;">外箱码</div> </div> <p>“XXXXXXXXXXXXXXXX” (一体机序列码) Made in China</p> | |

Note:

1. Material Code :Product ID.
2. P/N :Contents with "Order Information" in the specification.
3. Lot No. :Product data.
4. D/C :Product weeks.
5. Quantity :Packaging quantity.

12. Temperature Profile Of Soldering

(1).IR Reflow soldering (JEDEC-STD-020C compliant)

One time soldering reflow is recommended within the condition of temperature and time profile shown below. Do not solder more than three times.

| Profile item | Conditions |
|--------------------------------------|----------------|
| Preheat | |
| - Temperature Min (T Smin) | 150°C |
| - Temperature Max (T Smax) | 200°C |
| - Time (min to max) (ts) | 90±30 sec |
| Soldering zone | |
| - Temperature (TL) | 217°C |
| - Time (t L) | 60 sec |
| Peak Temperature | 260°C |
| Peak Temperature time | 20 sec |
| Ramp-up rate | 3°C / sec max. |
| Ramp-down rate from peak temperature | 3~6°C / sec |
| Reflow times | ≤3 |

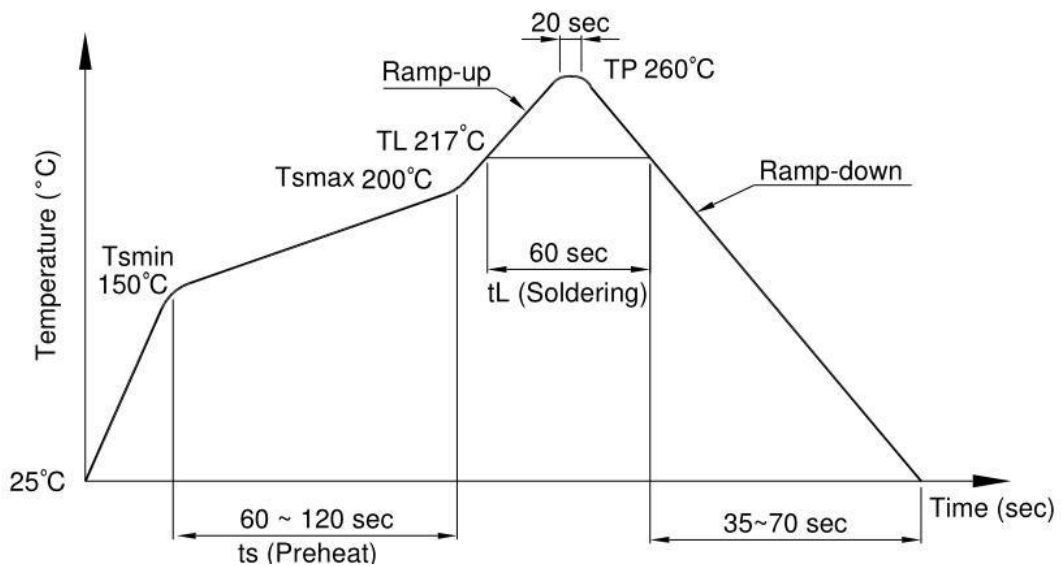

(3) .Wave soldering (JEDEC22A111 compliant)

One time soldering is recommended within the condition of temperature.

| | |
|---------------------|--------------|
| Temperature | 260+0/-5°C |
| Time | 10 sec |
| Preheat temperature | 5 to 140°C |
| Preheat time | 30 to 80 sec |

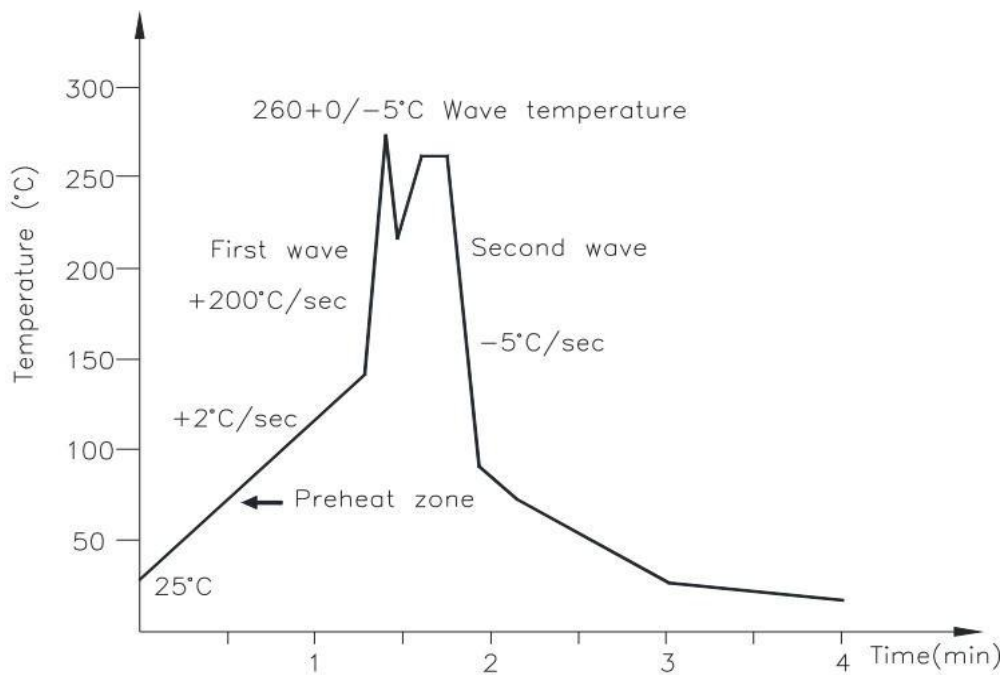

(3).Hand soldering by soldering iron

Allow single lead soldering in every single process. One time soldering is recommended.

| | |
|-------------|------------|
| Temperature | 380+0/-5°C |
| Time | 3 sec max |

13. CHARACTERISTICS CURVES (TYPICAL PERFORMANCE)

Fig.1 Forward Current vs. Ambient Temperature

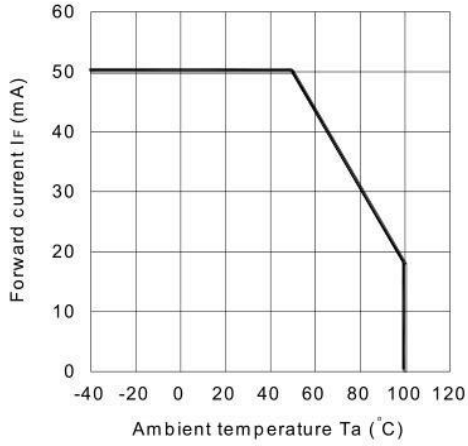

Fig.2 On-state Current vs. Ambient Temperature

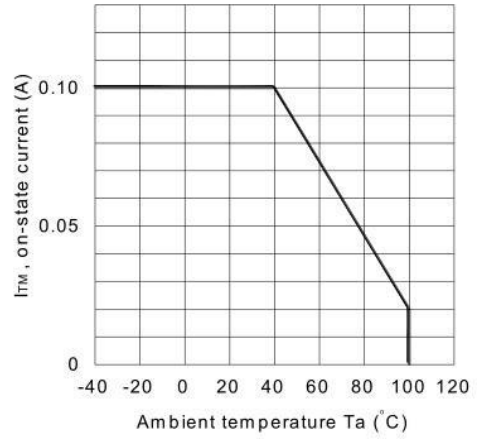

Fig.3 Minimum Trigger Current vs. Ambient Temperature

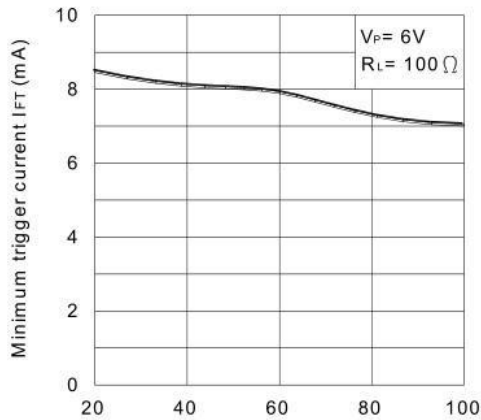

Fig.4 Forward Current vs. Forward Voltage

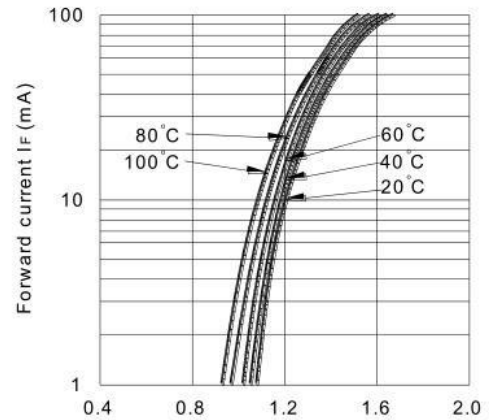

Fig.5 On-state Voltage vs. Ambient Temperature

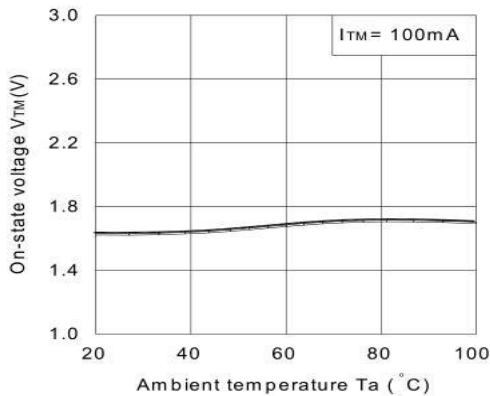

Fig.6 Holding Current vs. Ambient Temperature

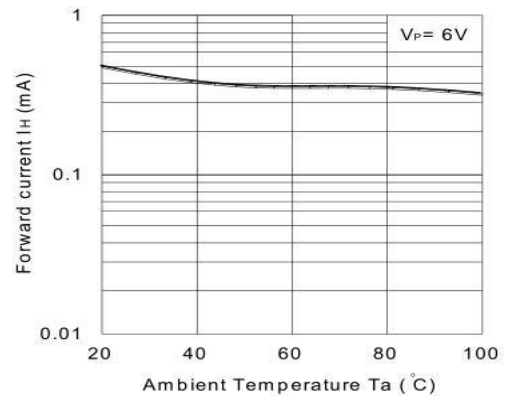

Fig.7 Repetitive Peak Off-state Current vs. Temperature

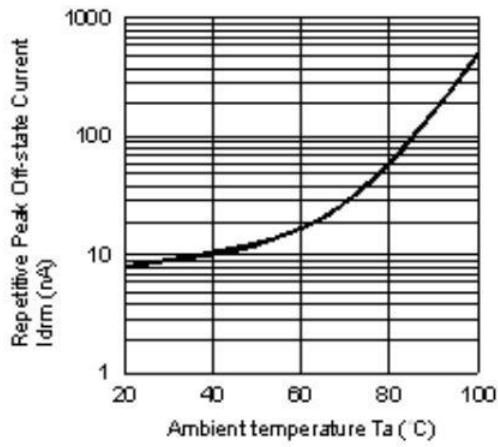
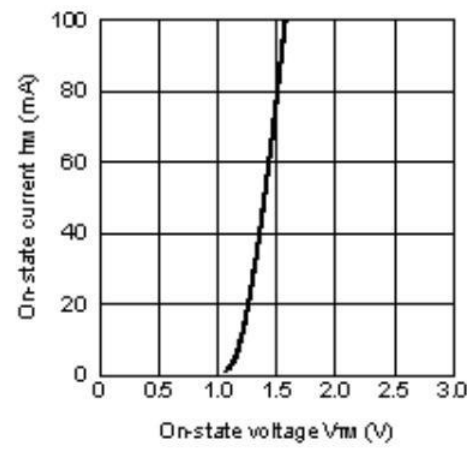

Fig.8 On-state Current vs. On-state Voltage



Basic Driver Circuit

