



# ORIENT

## Photo MOS Product

### Data Sheet

Part Number: OR-8XXA

Customer: \_\_\_\_\_

Date: \_\_\_\_\_

**SHENZHEN ORIENT COMPONENTS CO., LTD**

Block A 3rd Floor No.4 Building, Tian'an Cyber Park, Huangge Rd, LongGang Dist, Shenzhen, GD

TEL: 0755-29681816

FAX: 0755-29681200

[www.orient-opto.com](http://www.orient-opto.com)

## 1. Features

- (1) Compact 8-pin DIP size
- (2) Applicable for 2 Form A use as well as two independent 1Form A use
- (3) Controls low-level analog signals
- (4) High sensitivity and high speed response
- (5) Low-level off state leakage current of max. 1uA
- (6) Wide operating temperature range of -40°C to 85°C
- (7) High isolation voltage between input and output (Viso = 5000 Vrms)
- (8) Safety approval
  - UL approved(No.E323844)
  - VDE approved(No.40029733)
  - CQC approved (No.CQC19001231254)
- (9) In compliance with RoHS, REACH standards
- (10) MSL Level 1

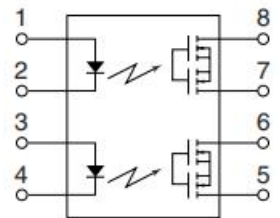
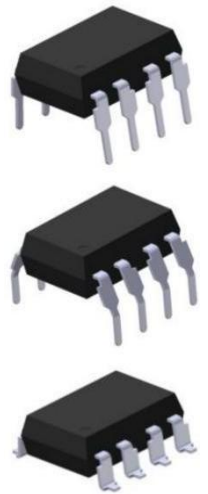

2, 4 LED Cathode  
8, 7, 6, 5 MOSFET

## 2. Description

The OR-806A, OR-825A, OR-840A and OR-860A are solid state relays containing an AlGaAs infrared LEDs on the light emitting side (input side) optically coupled to a high voltage output detector circuit. The detector consists of a photovoltaic diode array and MOSFETs on the output side. The dual channel configuration is equivalent to 1 form A EMR. They are packaged in 8 pin DIP and available in surface mount SMD option.

## 3. Application Range

- High-speed inspection machines
- Telephones equipment
- Computer

**4. Absolute Maximum Ratings (Ta=25°C)\*1**

Parameter		Symbol	Rated Value				Unit
			OR-806A	OR-825A	OR-840A	OR-860A	
Input	Average Forward Input Current	I <sub>F</sub>	50				mA
	Reverse Input Voltage	V <sub>R</sub>	5				V
	Peak Forward Current*1	I <sub>FP</sub>	1				A
	Power Dissipation	P <sub>IN</sub>	75				mW
Output	Break Down Voltage*2	V <sub>L</sub>	60	250	400	600	V
	Continuous Load Current*2	I <sub>L</sub>	550	150	120	50	mA
	Pulse Load Current*3	I <sub>LPeak</sub>	1.2	0.5	0.3	0.15	A
	Power Dissipation	P <sub>out</sub>	800				mW
Total Power Dissipation		P <sub>T</sub>	850				mW
Isolation Voltage*4		V <sub>iso</sub>	5000				V <sub>rms</sub>
Operating Temperature		T <sub>OPR</sub>	-40 ~ + 85				°C
Storage Temperature		T <sub>STG</sub>	-40 ~ + 125				
Soldering Temperature*5		T <sub>SOL</sub>	260				

Notes:

\*1. f=100Hz, Duty Cycle = 0.1%

\*2. Indicate the peak AC and DC values

 \*3. A connection: 100ms (1 shot), V<sub>L</sub> = DC or Peak AC

\*4. AC for 1 minute, R.H. = 40 ~ 60% R.H. In this test, pins 1, 2 are shorted together, and pins 3, 4 are shorted together.

\*5. For 10 seconds Opto-electronic Characteristics

**5. Electro-Optical Characteristics (Ta=25°C unless specified otherwise)**

Parameter		Symbol	Min.	Typ.	Max.	Unit	Condition	
<b>Input</b>	Forward Voltage	$V_F$	---	1.18	1.5	V	$I_F = 10\text{mA}$	
	Reverse Current	$I_R$	---	---	1	$\mu\text{A}$	$V_R = 5\text{V}$	
<b>Output</b>	Off State leakage Current	$I_{\text{leak}}$	---	---	1	$\mu\text{A}$	$I_F = 0\text{mA}, V_L = \text{Max.}$	
	On Resistance	OR-806A OR-825A OR-840A OR-860A	$R_d(\text{ON})$	---	0.7	2.5	$\Omega$	$I_F = 10\text{mA},$ $I_L = \text{Max.},$ $t = 1\text{s}$
				---	6.5	15		
				---	20	30		
				---	40	70		
	Output Capacitance	OR-806A OR-825A OR-840A OR-860A	$C(\text{out})$	---	85	---	pF	$V_L = 0\text{V}, f = 1\text{MHz}$
				---	60	---		
				---	45	---		
---				30	---			
<b>Transfer Characteristics</b>	LED turn on Current	OR-806A OR-825A OR-840A OR-860A	$I_F(\text{on})$	---	2.9	5	mA	$I_L = \text{Max.}$
				---	2.84	5		
				---	2.92	5		
				---	2.38	5		
	LED turn off Current	OR-806A OR-825A OR-840A OR-860A	$I_F(\text{off})$	0.4	2.74	---	mA	$I_L = \text{Max.}$
				0.4	2.72	---		
				0.4	2.78	---		
				0.4	2.26	---		
	Turn On Time	OR-806A OR-825A OR-840A OR-860A	$T_{\text{on}}$	---	1.4	3	ms	$I_F = 10\text{mA},$ $I_L = \text{Max.},$ $R_L = 200\Omega$
				---	1.2	3		
				---	0.4	3		
				---	1.4	3		
	Turn Off Time	OR-806A OR-825A OR-840A OR-860A	$T_{\text{off}}$	---	0.05	0.5	ms	$I_F = 10\text{mA},$ $I_L = \text{Max.},$ $R_L = 200\Omega$
				---	0.05	0.5		
---				0.05	0.5			
---				0.05	0.5			
Isolation Resistance		$R_{I-O}$	$5 \times 10^{10}$	$1 \times 10^{12}$	---	$\Omega$	$V_{I-O} = 500\text{V DC}$	
Isolation Capacitance		$C_{I-O}$	---	1.5	---	pF	$V = 0\text{V}, f = 1\text{MHz}$	

## 6. Order Information

Part Number

**OR-8XXAU-Y-Z**

Note

8XXA = Part Number. ( 806A ,825A ,840A or 860A)

U = Lead form option (S, M or none)

Y = Tape and reel option ( TA,TA1 or none).

Z = ‘V’ code for VDE safety (This options is not necessary).

\* VDE Code can be selected.

Option	Description	Packing quantity
None	Standard SMD Option	45 units per tube
M	Wide lead bend (0.4 inch spacing)	45 units per tube
TA	Surface mount lead form (low profile) + TP tape & reel option	1000 units per reel
TA1	Surface mount lead form (low profile) + TP1 tape & reel option	1000 units per reel

## 7. Naming Rule

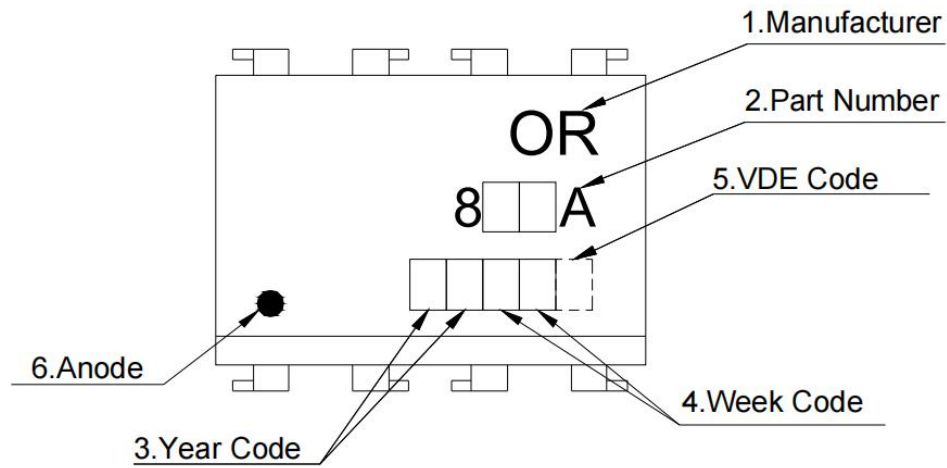

### NOTE:

1. Manufacturer : ORIENT.
2. Part Number : 806A, 825A, 840A or 860A.
3. Year Code [ ] [ ] : '21' means '2021' and so on.
4. Week Code [ ] [ ]: 01 represents the first week, 02 represents the second week, and so on.
5. VDE Code [ ] [ ] [ ] [ ] . (Optional)
6. Anode.

## 8. Outer Dimension

### (1) OR-8XXA

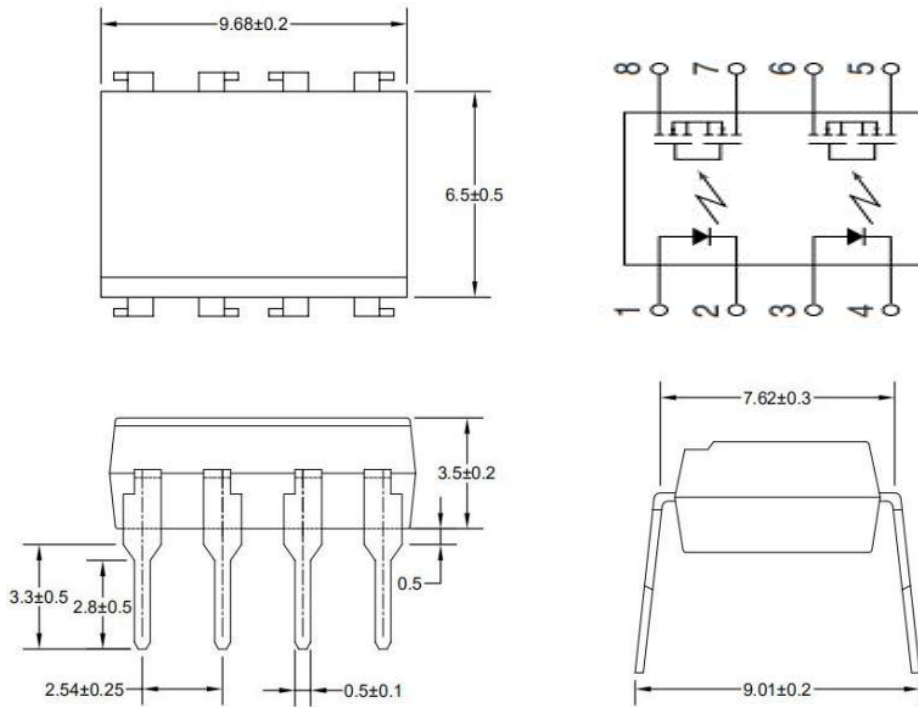

### (2) OR-8XXAM

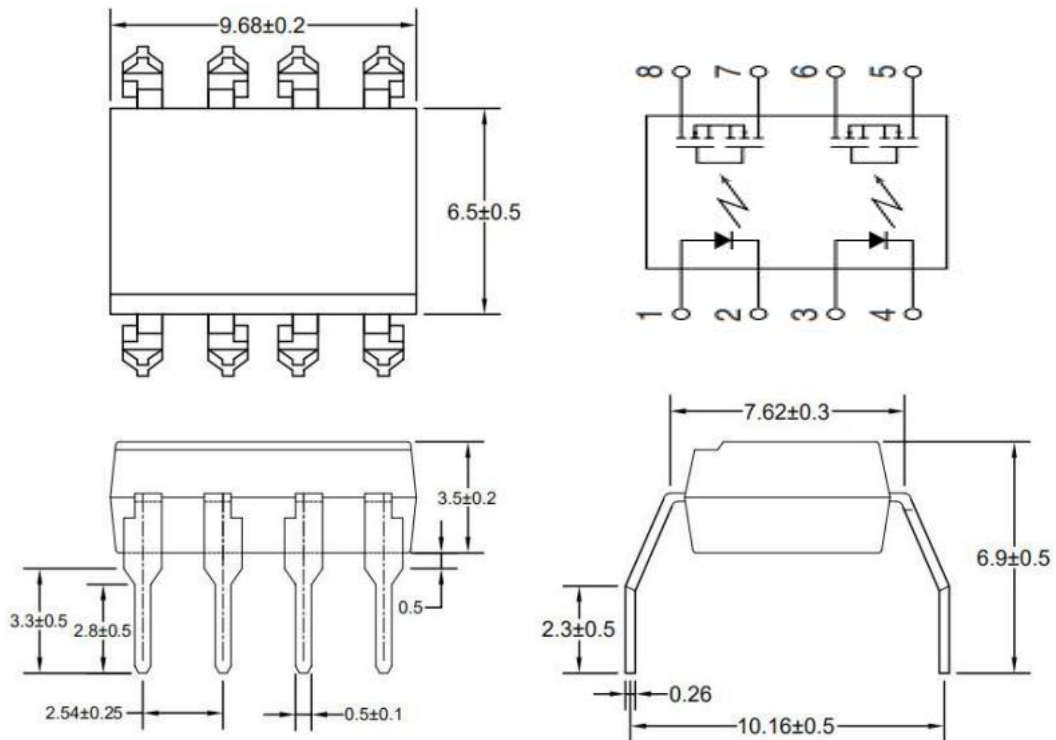

**(3) OR-8XXAS**

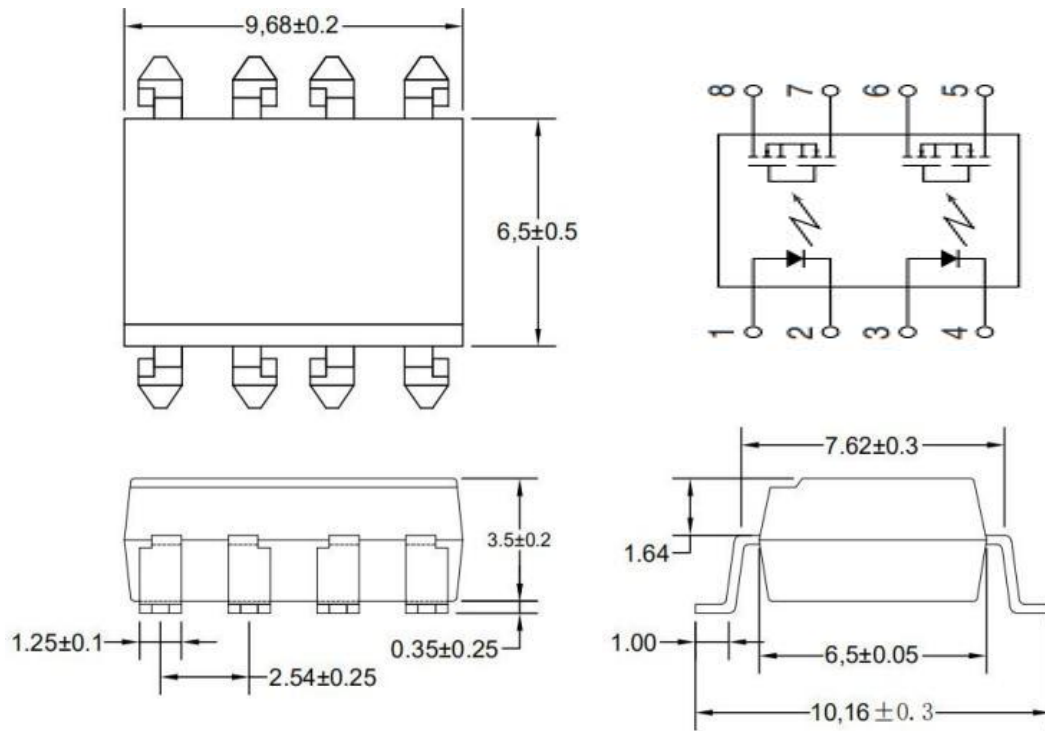

**9. Recommended Foot Print Patterns (Mount Pad)**

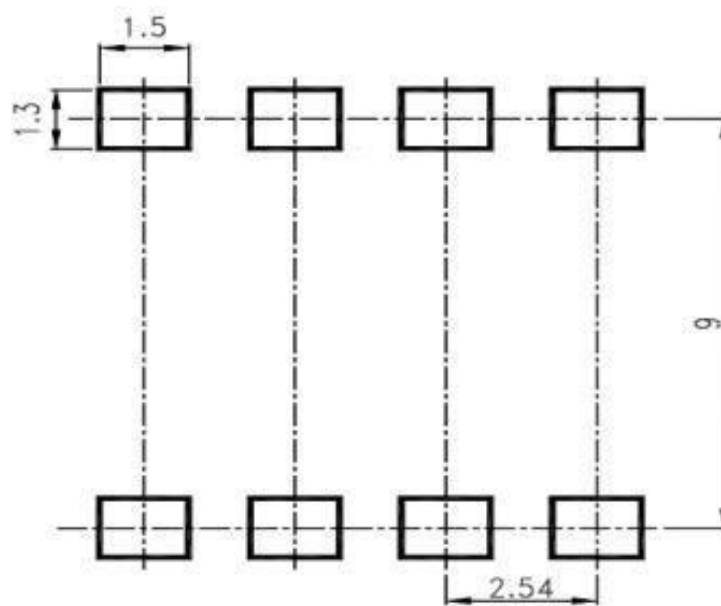

(unit: mm)



### 10. Taping Dimensions

#### (1) OR-8XXA-TA

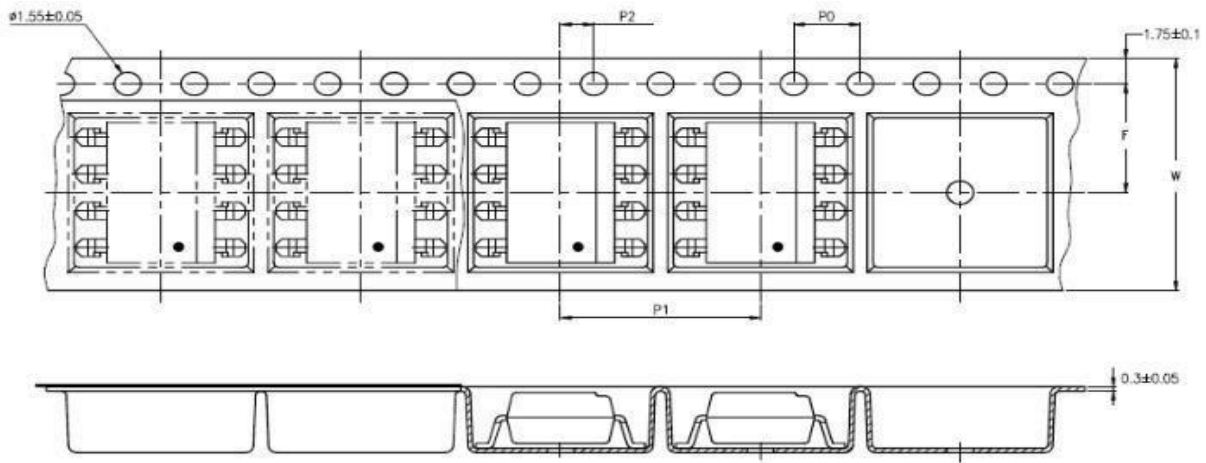

#### (2) OR-8XXA-TA1

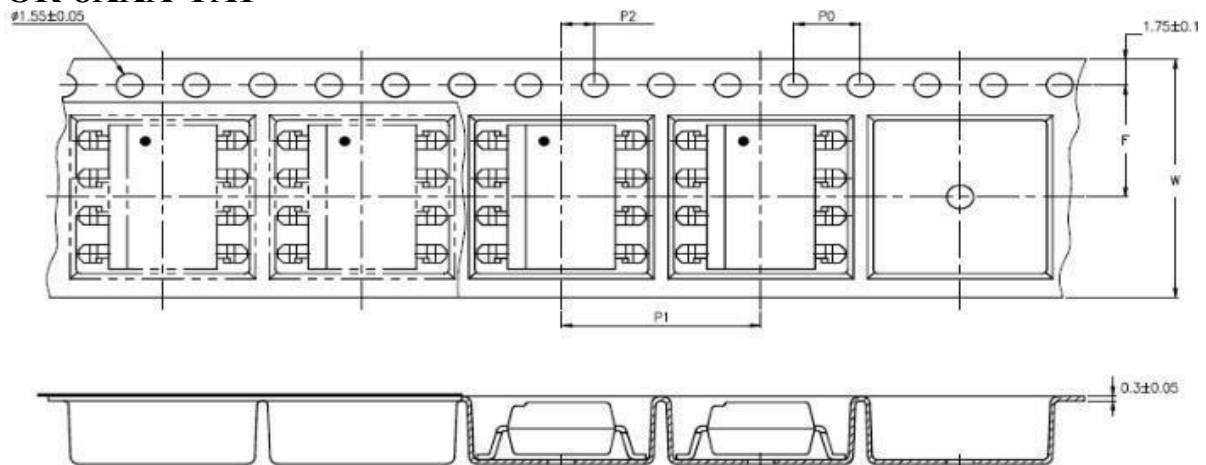

type	symbol	Size: mm (inches)
bandwidth	W	16±0.3 (0.63)
pitch	P0	4±0.1 (0.15)
	F	7.5±0.1 (0.295)
interval	P2	2±0.1 (0.079)
	P1	12±0.1 (0.472)

Encapsulation type	TA/TA1
Amount (pcs)	1000

## 11. Package Dimension

### (1) package dimension

DIP/M type

Packing Information	
Packing type	Tube
Qty per Tube	45pcs
Small box (Inner) Dimension	525*128*60mm
Large box (Outer) Dimension	545*290*335mm
The Amount per Inner Box	2,250pcs
The Amount per Outer Box	22,500pcs



SOP type

Packing Information	
Packing type	Reel type
Tape Width	16mm
Qty per Reel	1,000pcs
Small box (inner) Dimension	345*345*58.5mm
Large box (Outer) Dimension	620x360x360mm
Max qty per small box	2,000pcs
Max qty per large box	20,000pcs

### (2)Packing Label Sample



Material Code : 120PCXXXXXX  
P/N : OR-XXXXXX  
Lot No. : XXXXXX-XXXXX-TX-X  
D/C : XXXX  
Qty : XXXX PCS

内箱码

外箱码

“XXXXXXXXXXXXXXXX” (一体机序列码)

Made in China

#### Note:

1. Material Code :Product ID.
2. P/N :Contents with "Order Information" in the specification.
3. Lot No. :Product data.
4. D/C :Product weeks.
5. Quantity :Packaging quantity.

## 12. Temperature Profile Of Soldering

### 1. IR Reflow soldering (JEDEC-STD-020C compliant)

One time soldering reflow is recommended within the condition of temperature and time profile shown below.

Do not solder more than three times.

Profile item	Conditions
Preheat	
- Temperature Min (T Smin )	150°C
- Temperature Max (T Smax )	200°C
- Time (min to max) (ts)	90±30 sec
Soldering zone	
- Temperature (TL )	217°C
- Time (t L )	60 sec
Peak Temperature	260°C
Peak Temperature time	20 sec
Ramp-up rate	3°C / sec max.
Ramp-down rate from peak temperature	3~6°C / sec
Reflow times	≤3

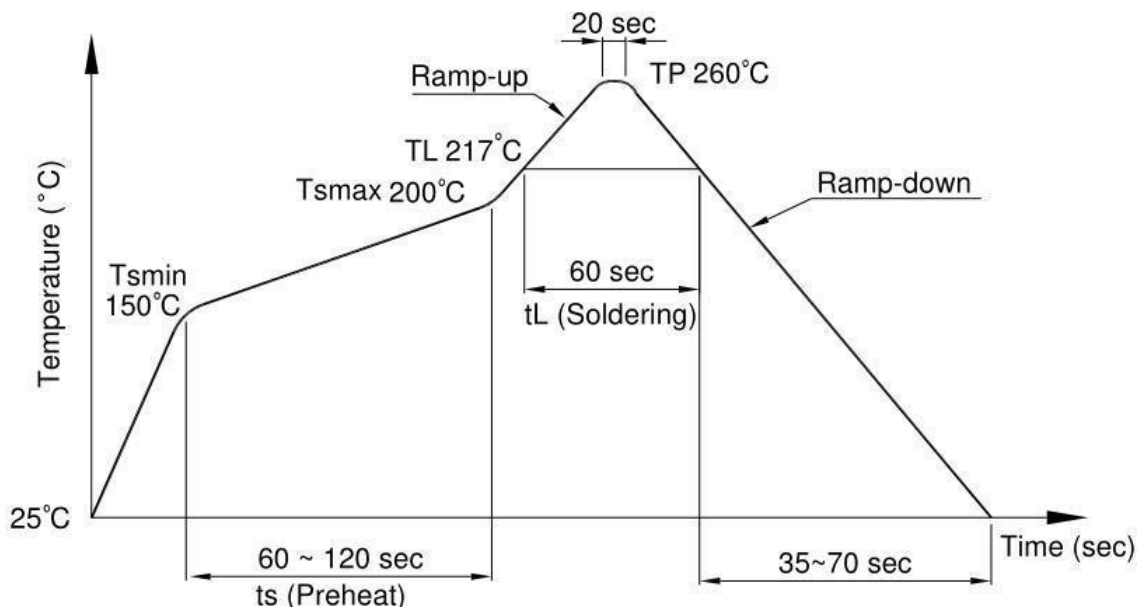

### 13. Wave soldering (JEDEC22A111 compliant)

One time soldering is recommended within the condition of temperature.

Temperature	260+0/-5°C
Time	10 sec
Preheat temperature	5 to 140°C
Preheat time	30 to 80 sec

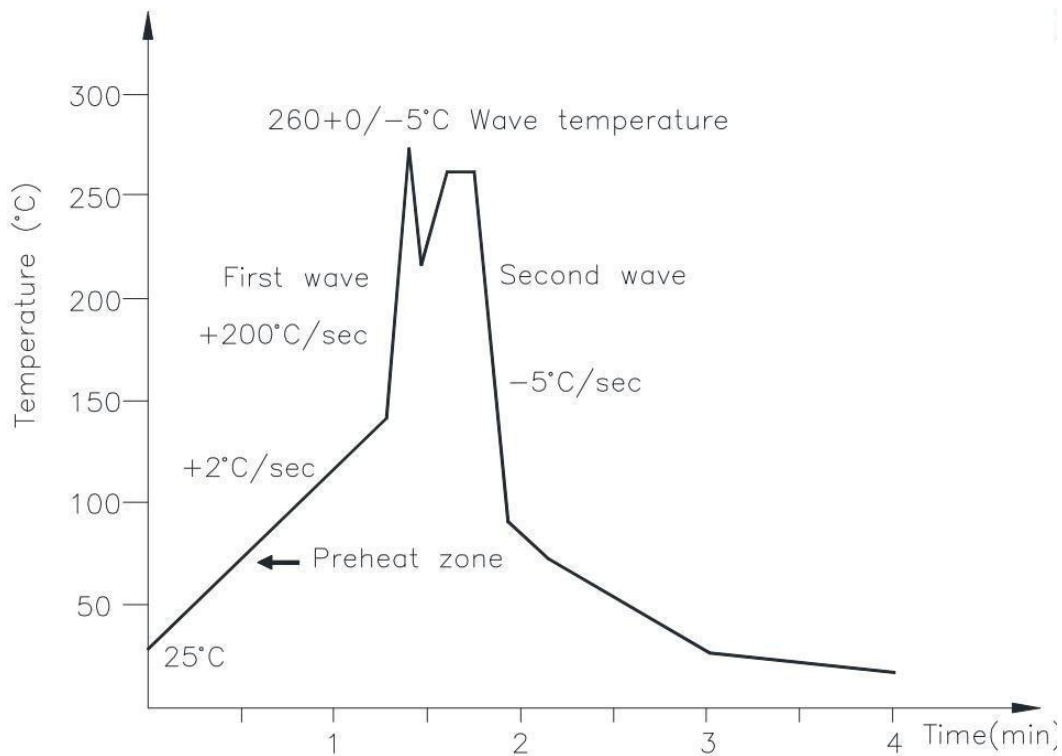

#### 2. Hand soldering by soldering iron

Allow single lead soldering in every single process. One time soldering is recommended.

Temperature	380+0/-5°C
Time	3 sec max

### 14. Typical Electro-Optical Characteristics Curves

Figure 1-1. Load current vs Ambient temperature

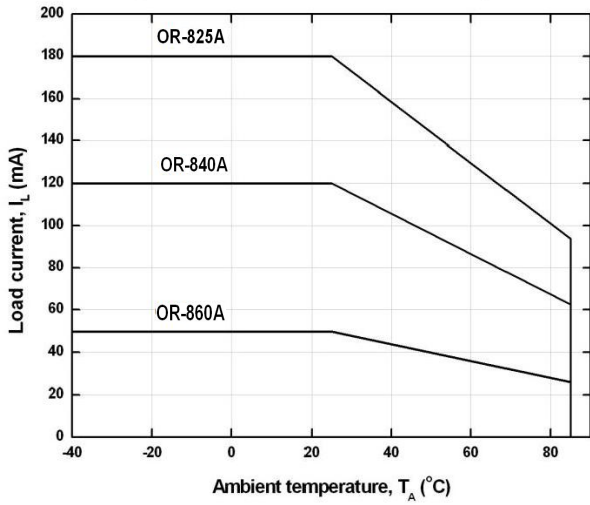

Figure 1-2. Load current vs Ambient temperature

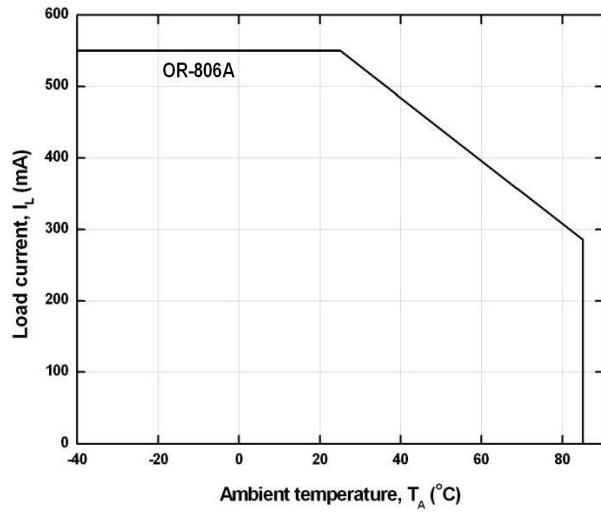

Figure 2-1. On Resistance vs Ambient Temperature

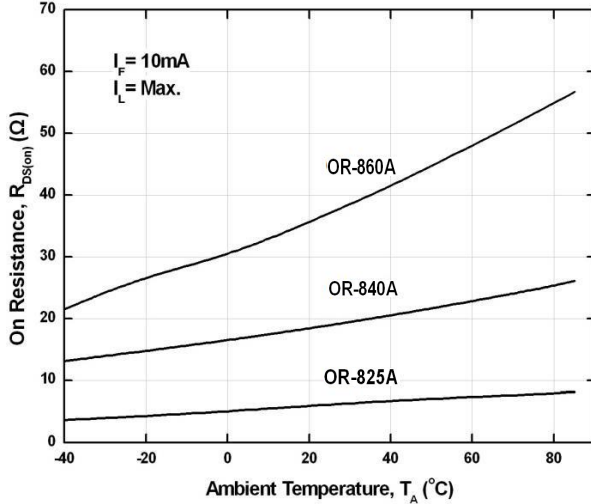

Figure 2-2. On Resistance vs Ambient Temperature

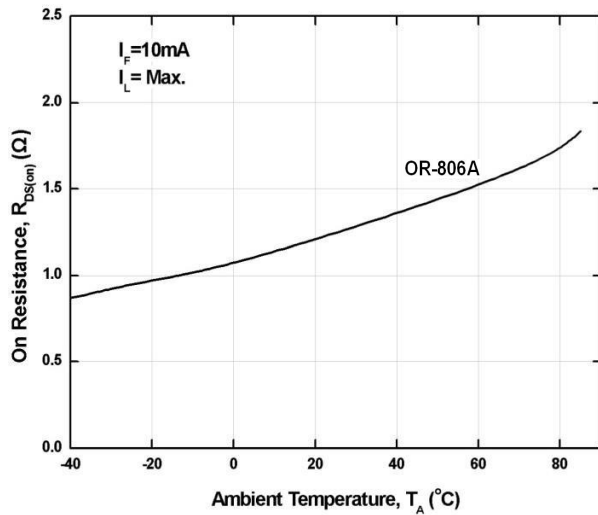

Figure 3. Switching Time vs Ambient Temperature

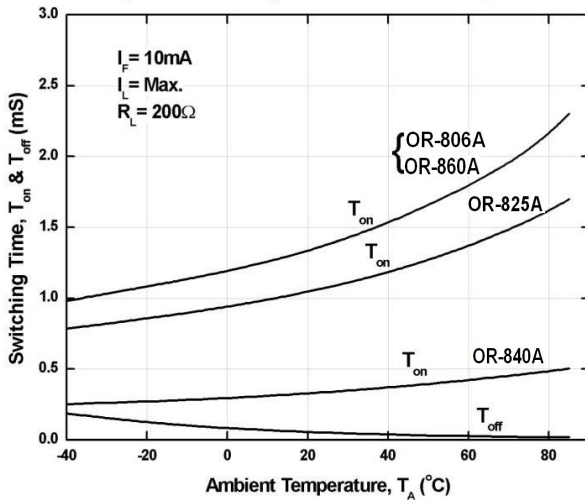

Figure 4-1. Turn On Time vs LED Forward Current

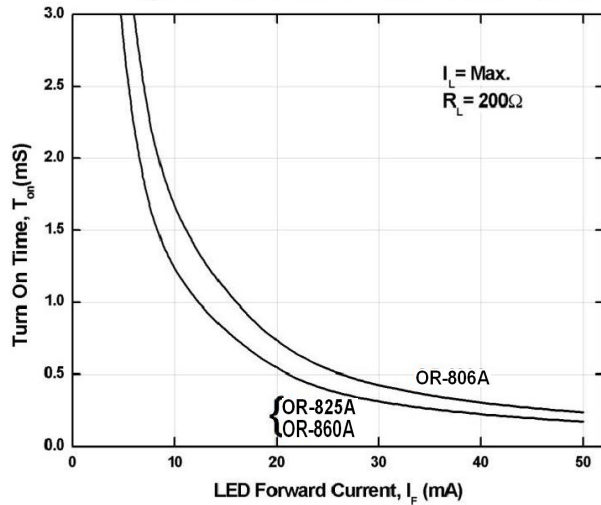

Figure 4-2. Turn On Time vs LED Forward Current

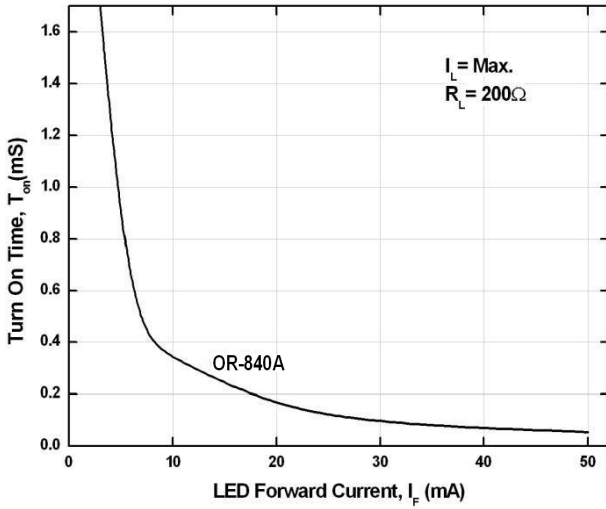

Figure 5. Turn Off Time vs LED Forward Current

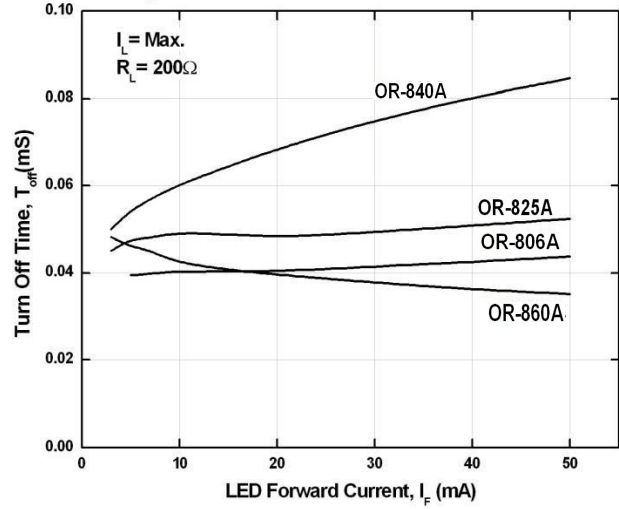

Figure 6. Normalized LED Operate on Current vs Ambient Temperature

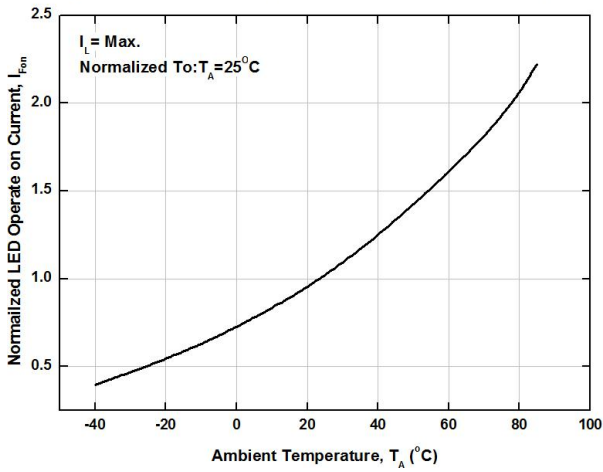

Figure 7. Normalized LED Turn off Current vs Ambient Temperature

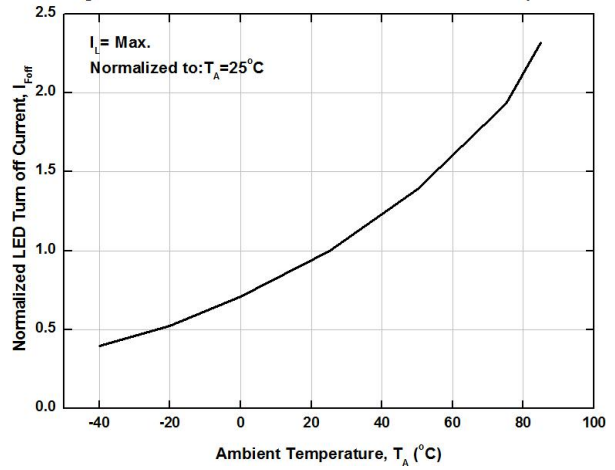

Figure 8. LED Dropout Voltage vs Ambient Temperature

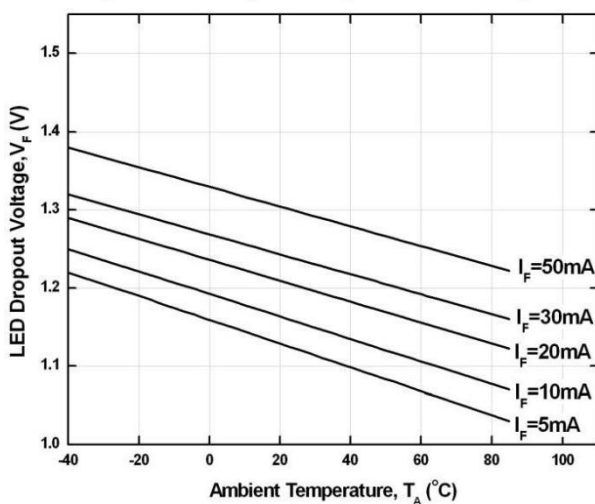

Figure 9-1. Load Voltage vs Load Current

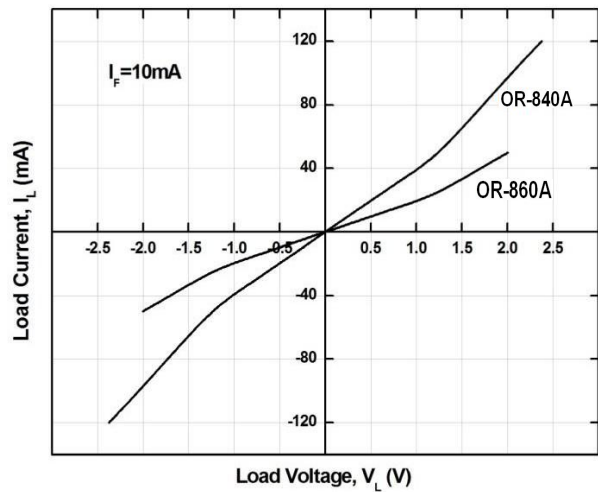

Figure 9-2. Load Voltage vs Load Current

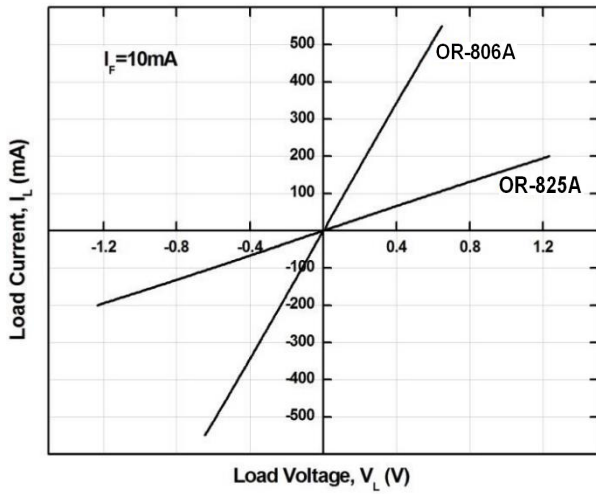

Figure 10. Off State Leakage Current vs Load Voltage

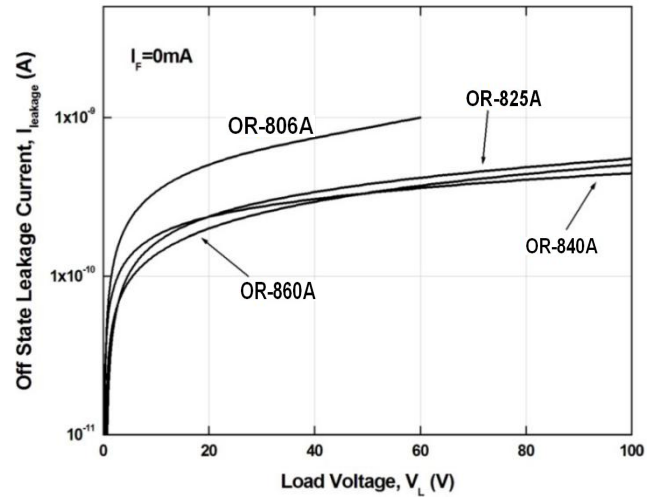
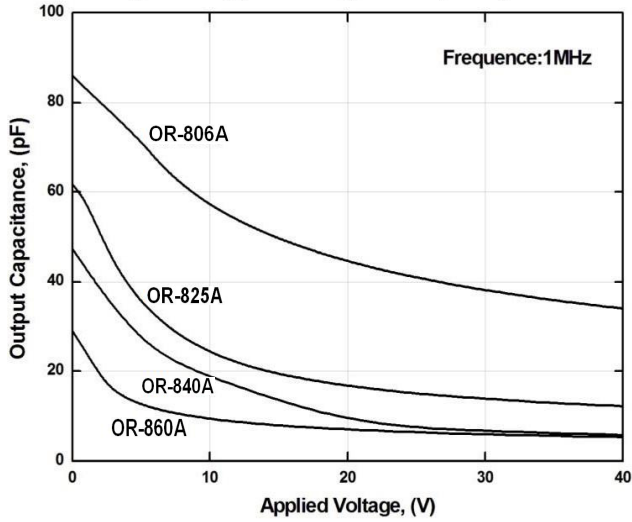

Figure 11. Applied Voltage VS Output Capacitance



Turn on/Turn off Time

