



ORIENT

Photo coupler

Product Data Sheet

Part Number: OR-50L

Customer: _____

Date: _____

SHENZHEN ORIENT COMPONENTS CO., LTD

Block A 3rd Floor No.4 Building, Tian'an Cyber Park, Huangge Rd, LongGang Dist, Shenzhen, GD

TEL: 0755-29681816

FAX: 0755-29681200

www.orient-opto.com

1. Features

- (1) High common mode transient immunity ($CM_H, CM_L = 15 \text{ kV}/\mu\text{s MIN.}$)
- (2) Half size of 8-pin DIP
- (3) Long creepage distance
- (4) High supply voltage ($V_{CC} = 35 \text{ V}$)
- (5) High isolation voltage ($V_{ISO} = 5000 \text{ Vrms.}$)
- (6) High-speed response ($t_{PHL}=0.8\text{s MAX.}, t_{PLH}=0.8\text{s MAX.}$)
- (7) Safety approval
 - UL approved(No.E323844)
 - VDE approved(No.40029733)
 - CQC approved (No.CQC19001231480)
- (8) In compliance with RoHS, REACH standards
- (9) MSL Level 1

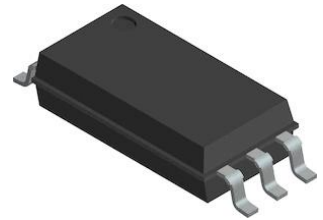

2. Description

The OR-50L are optical coupled isolators containing a GaAlAs LED on the input side and a PIN photodiode and a high-speed amplifier transistor on the output side on one chip. Designed specifically for high supply voltage and high common mode transient immunity (CMR). They are in 6-pin plastic SDIP (Shrink Dual In-line Package). The OR-50L has 8 mm creepage distance and is half size of 8-pin DIP.

The OR-50LW is lead bending type for long creepage distance (Gull-wing) for surface mount.

The OR-50LW1 is lead bending type (Gull-wing) for surface mounting.

3. Application Range

- (1) Computer and peripheral manufactures
- (2) General purpose inverter
- (3) Substitutions for relays and pulse transformers
- (4) Power supply

4. Functional Diagram

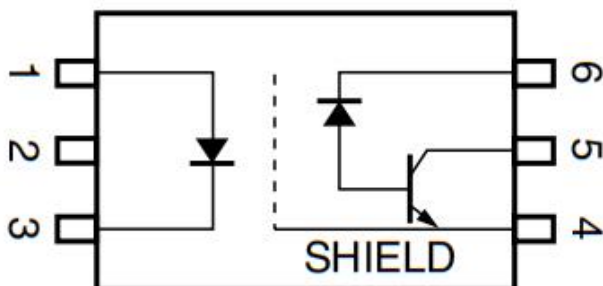

- 1. Anode
- 2. NC
- 3. Cathode
- 4. GND
- 5. Vo
- 6. Vcc

5. Absolute Maximum Ratings (Ta=25°C)

Parameter		Symbol	Ratings	Unit
Diode	Forward Current ^{*1}	I _F	40	mA
	Reverse Voltage	V _R	5	V
Detector	Supply Voltage	V _{CC}	35	V
	Output Voltage	V _O	35	V
	Output Current	I _O	8	mA
	Power Dissipation ^{*2}	P _C	100	mW
Insulation Voltage	OR-50LW	Viso	5000	Vrms
	OR-50LW1		3750	
Operating Ambient Temperature		T _{Opr}	-40 to +105	°C
Storage Temperature		T _{stg}	-55 to +125	°C

(1) Reduced to 0.3 mA/°C at T_A = 70°C or more.

(2) Reduced to 2.0 mW/°C at T_A = 75°C or more.

(3) AC voltage for 1 minute at T_A = 25°C, RH = 60% between input and output.

Pins 1-3 shorted together, 4-6 shorted together.

6. Electrical Optical Characteristics at Ta=25°C

Parameter		Symbol	MIN.	TYP.	MAX.	Unit	Conditions
I N P U T	Forward Voltage	V_F	---	1.6	2.0	V	$I_F = 16\text{mA}$
	Reverse Current	I_R	---	---	10	μA	$V_R = 3\text{V}$
	Forward Voltage Temperature Coefficient	$\Delta V_F/\Delta T_A$	---	2.1	---	mV/C	$I_F = 16\text{mA}$
	Terminal Capacitance	C_t	---	30	---	pF	$V = 0\text{V}, f = 1\text{MHz}$
O U T P U T	High Level Output Current	$I_{OH}(1)$	---	3	500	nA	$I_F = 0\text{mA}, V_{CC} = V_O = 5.5\text{V}$
	High Level Output Current	$I_{OH}(2)$	---	---	100	μA	$I_F = 0\text{mA}, V_{CC} = V_O = 35\text{V}$
	Low Level Output Voltage	V_{OL}	---	0.15	0.4	V	$I_F = 16\text{mA}, V_{CC} = 4.5\text{V}$ $I_O = 2.4\text{mA}$
	High Level Supply Current	I_{CCH}	---	0.01	1	μA	$I_F = 0\text{mA}, V_O = \text{open},$ $V_{CC} = 35\text{V}$
	Low Level Supply Current	I_{CCL}	---	150	---		$I_F = 16\text{mA}, V_O = \text{open},$ $V_{CC} = 35\text{V}$
C O U T P L E D	Current Transfer Ratio	CTR	15	---	---	%	$I_F = 16\text{mA}, V_{CC} = 4.5\text{V},$ $V_O = 0.4\text{V}$
	Input-Output Isolation Resistance	RI-O	10^{11}	---	---	Ω	$V_{LO} = 1\text{kV DC}$
	Input-Output Isolation Capacitance	CI-O	---	0.7	---	pF	$V = 0\text{V}, f = 1\text{MHz}$
	Propagation Delay Time (H \rightarrow L)*2	t_{PHL}	---	0.3	0.8	μs	$I_F = 16\text{mA},$ $V_{CC} = 5\text{V},$ $R_L = 1.9\text{k}\Omega$
	Propagation Delay Time (L \rightarrow H) *2	t_{PLH}	---	0.33	0.8		
	Common Mode Transient Immunity at High Level Output*3	CM_H	15	---	---	KV/ μs	$I_F = 0\text{mA}, V_{CC} = 5\text{V},$ $R_L = 4.1\text{k}\Omega, V_{CM} = 1.5\text{kV}$
	Common Mode Transient Immunity at Low Level Output*3	CM_L	15	---	---		$I_F = 16\text{mA}, V_{CC} = 5\text{V},$ $R_L = 4.1\text{k}\Omega, V_{CM} = 1.5\text{kV}$

(1) Typical values at $T_A = 25^\circ\text{C}$

(2) Test circuit for propagation delay time(Figure on Page 15)

(3) Test circuit for common mode transient immunity(Figure on Page 15)



7. Order Information

Part Number

OR-50LX-Y-Z

Note

50L = Part Number.

X = Lead form option (W or W1)

Y = Tape and reel option (TA,TA1 or none).

Z = 'V' code for VDE safety (This options is not necessary).

* VDE Code can be selected.

Option	Description	Packing quantity
S(TA)	Surface mount lead form (low profile) + TA tape & reel option	1000 units per reel
S(TA1)	Surface mount lead form (low profile) + TA1 tape & reel option	1000 units per reel

8. Naming Rule

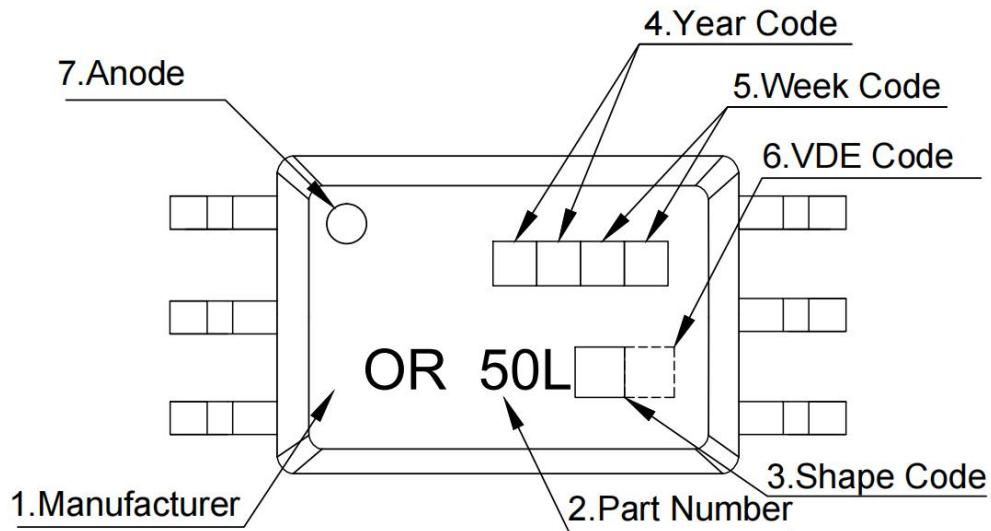

1. Manufacturer : ORIENT.
2. Part Number : 50L .
3. Shape Code : Lead form option ,W or W1
4. Year Code : '21' means '2021' and so on.
5. Week Code : 01 means the first week, 02 means the second week and so on.
6. VDE Code . (Optional)
7. Anode.

* VDE Mark can be selected.

9. Package Dimension

(1).OR-50LW

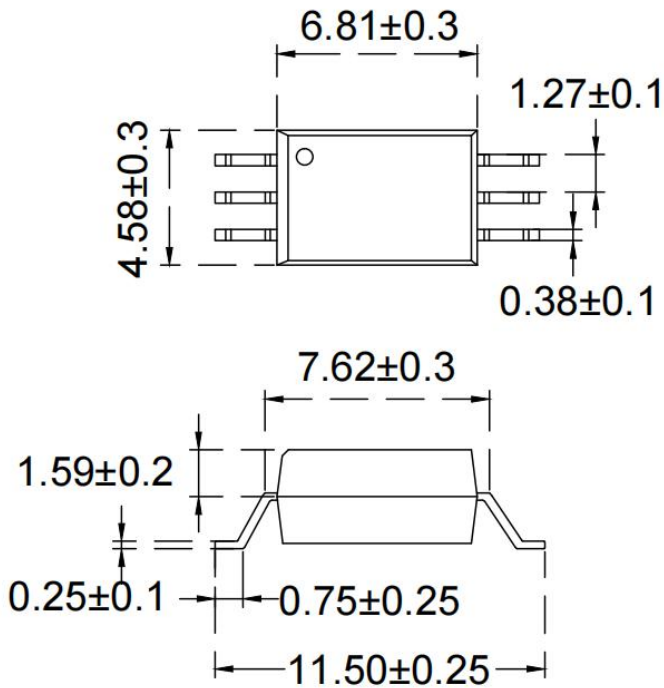

Land Pattern Recommendation

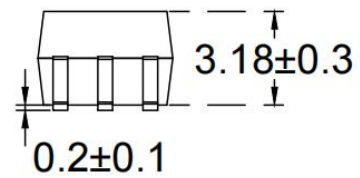
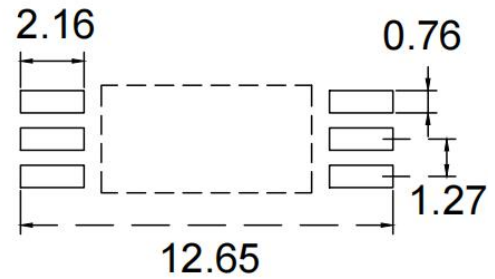

(2).OR-50LW1

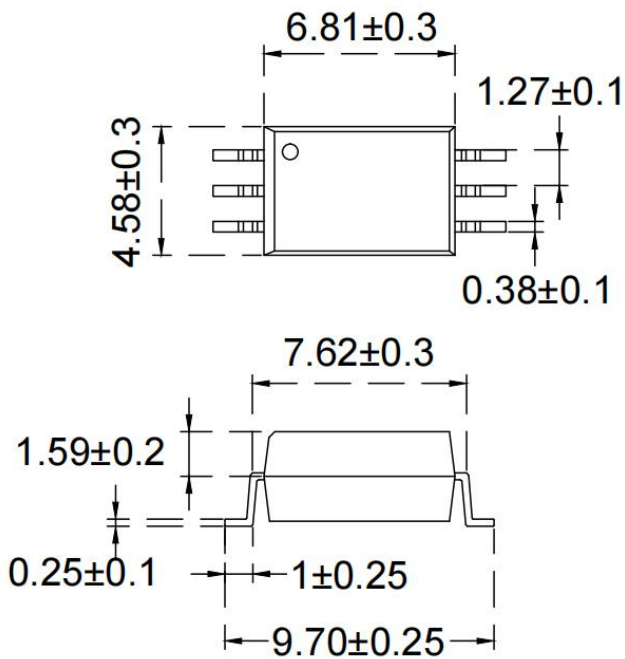

Land Pattern Recommendation

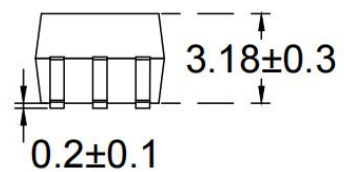
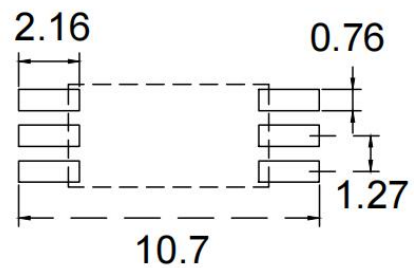

10. Taping Dimensions

(1)OR-50LW-TA

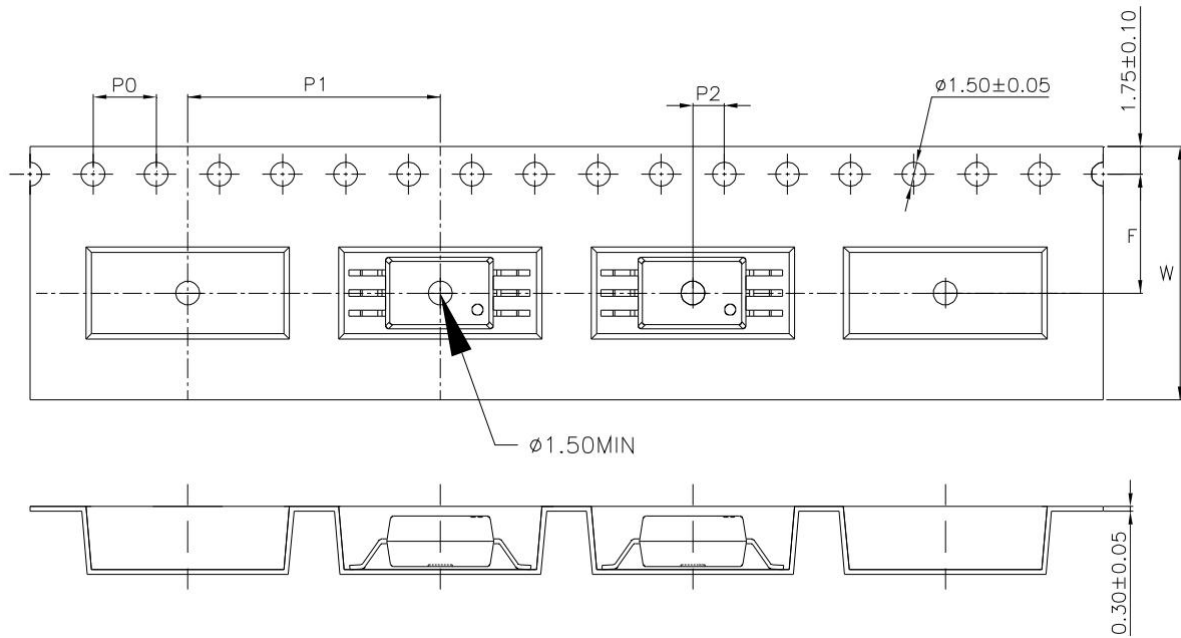

(2)OR-50LW-TA1

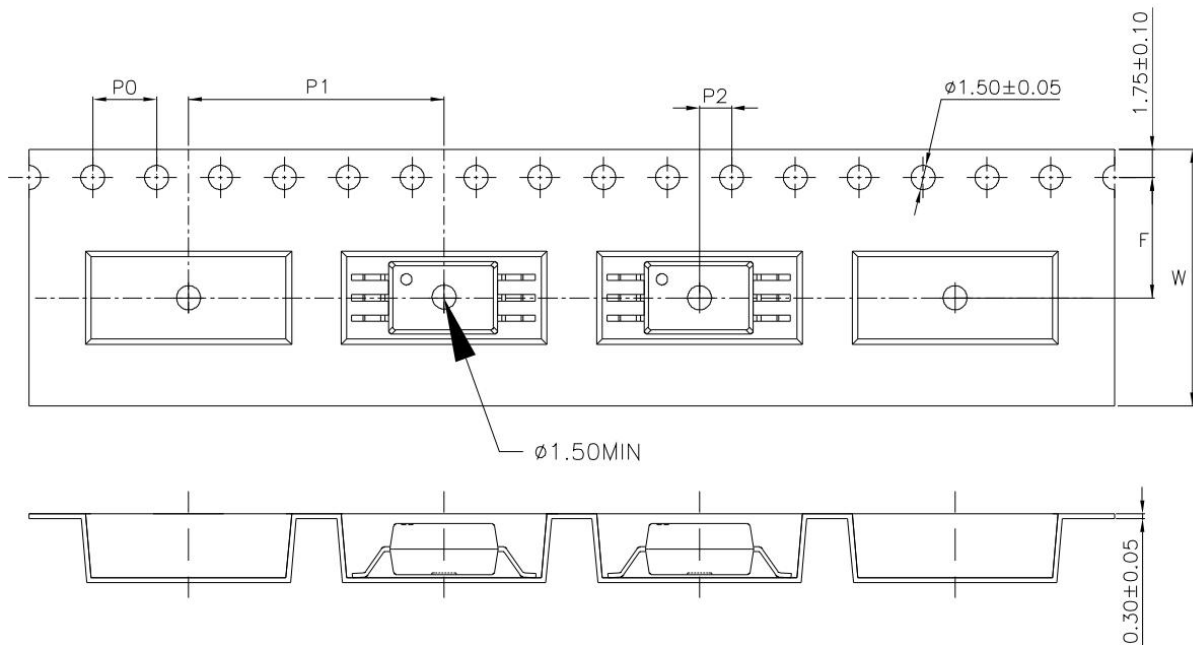

(1)OR-50LW1-TA

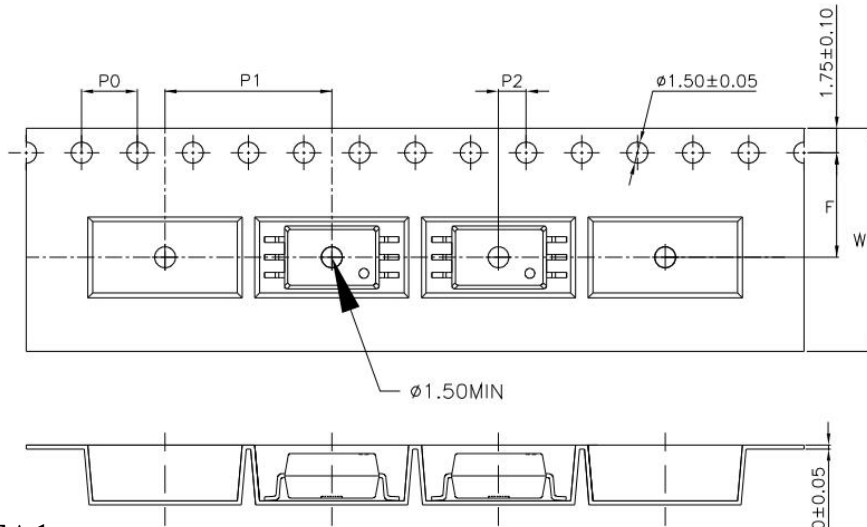

(2)OR-50LW1-TA1

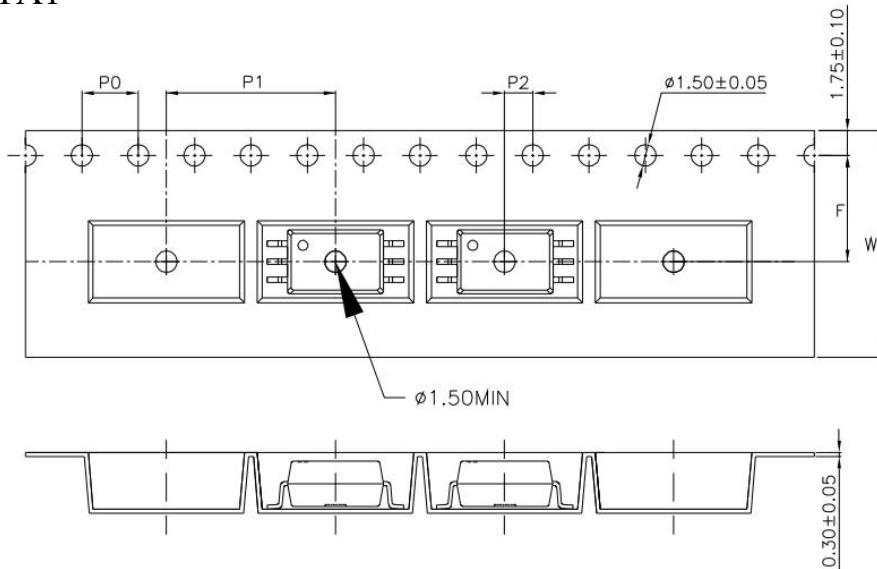

Type	symbol	Dimension in mm (inch) For W type	Dimension in mm (inch) For W1 type
bandwidth	W	16 ± 0.3 (0.63)	16 ± 0.3 (0.63)
pitch	P0	4 ± 0.1 (0.16)	4 ± 0.1 (0.16)
pitch	F	7.5 ± 0.1 (0.3)	7.5 ± 0.1 (0.3)
	P2	2 ± 0.1 (0.079)	2 ± 0.1 (0.079)
interval	P1	16 ± 0.1 (0.63)	12 ± 0.1 (0.47)

Encapsulation type	TA/TA1
amount (pcs)	1000

11. Package Dimension

(1) package dimension

Packing Information	
Packing type	Reel type
Tape Width	16mm
Qty per Reel	1,000pcs
Small box (inner) Dimension	345*345*58.5mm
Large box (Outer) Dimension	620x360x360mm
Max qty per small box	2,000pcs
Max qty per large box	20,000pcs

(2) Packing Label Sample

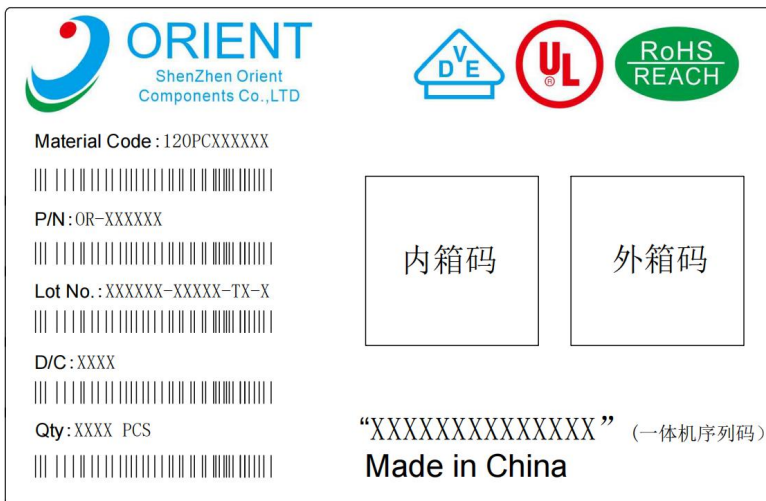

The label features the ORIENT logo (ShenZhen Orient Components Co.,LTD) and compliance icons for DVE, UL, and RoHS REACH. It includes the following text and barcodes:

- Material Code : 120PCXXXXXX
- P/N : OR-XXXXXX
- Lot No. : XXXXXX-XXXXX-TX-X
- D/C : XXXX
- Qty : XXXX PCS

Two boxes are labeled "内箱码" (Inner Box Code) and "外箱码" (Outer Box Code). At the bottom, it displays "XXXXXXXXXXXXXXXX" (一体机序列码) and "Made in China".

Note:

1. Material Code :Product ID.
2. P/N :Contents with "Order Information" in the specification.
3. Lot No. :Product data.
4. D/C :Product weeks.
5. Quantity :Packaging quantity.

12. Reliability Test

NO.	ITEMS	Reliability Testing				
		QTY. (Pcs)	Condition	Process	Device	Standard
1	RSH 耐焊接热	22	260±5°C	5s/3 次	锡炉	JESD22-A106
2	HTSL 高温存储	77	125°C	168 hrs	高温烤箱 测试仪	JESD22-A103
				500 hrs		
				1000 hrs		
3	LTSL 低温存储	77	-40°C	168 hrs	低温箱 测试仪	JESD22-A119
				500 hrs		
				1000 hrs		
4	TC 温度循环	77	H:125°C 15min ↓5min L:-55°C 15min	300 cycle	冷热冲击 机	JESD22-A104
5	TS 温度冲击	77	H:100°C 5min ↓15s L:-40°C 5min	300 cycle	冷热冲击 机	JESD22-A106
6	HTOL 高温操作	77	100°C IF=10mA Vcc=5V	168 hrs	高温烤箱 测试仪、 老化电路 板	JESD22-A108
				500 hrs		
				1000 hrs		
7	ESD- HBM 人体模式	22	≥8KV 1Cycle	1次	ESD静电 测试仪	JESD22-A114
8	SD 可焊性	22	Pb-free 245±5°C	5s/1次	锡炉	JESD22-B102
9	HTHB 温湿寿命 试验	77	85°C,85%RH IF=10mA,Vcc=5V	168 hrs	恒温恒湿 机, 测试 仪	JESD22-A101
				500 hrs		
				1000 hrs		
10	Autoclave 压力锅	77	Ta=121 °C,100%RH,2atm	96hrs	压力锅	JESD22-A102

13. Temperature Profile Of Soldering

(1).IR Reflow soldering (JEDEC-STD-020C compliant)

One time soldering reflow is recommended within the condition of temperature and time profile shown below. Do not solder more than three times.

Profile item	Conditions
Preheat - Temperature Min (T Smin) - Temperature Max (T Smax) - Time (min to max) (ts)	150°C 200°C 90±30 sec
Soldering zone - Temperature (TL) - Time (t L)	217°C 60 sec
Peak Temperature	260°C
Peak Temperature time	20 sec
Ramp-up rate	3°C / sec max.
Ramp-down rate from peak temperature	3~6°C / sec
Reflow times	≤3

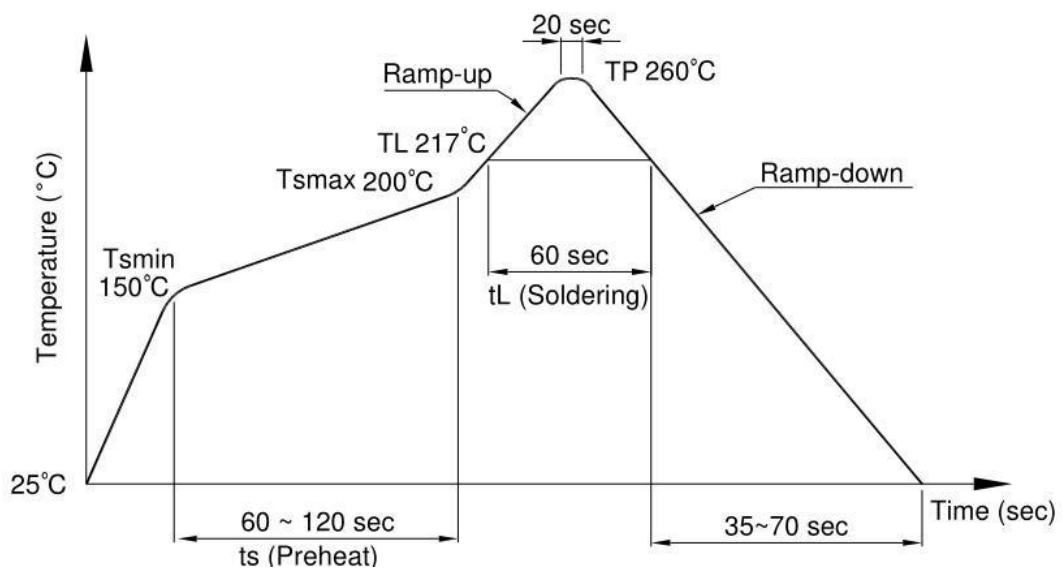

(3) .Wave soldering (JEDEC22A111 compliant)

One time soldering is recommended within the condition of temperature.

Temperature	260+0/-5°C
Time	10 sec
Preheat temperature	5 to 140°C
Preheat time	30 to 80 sec

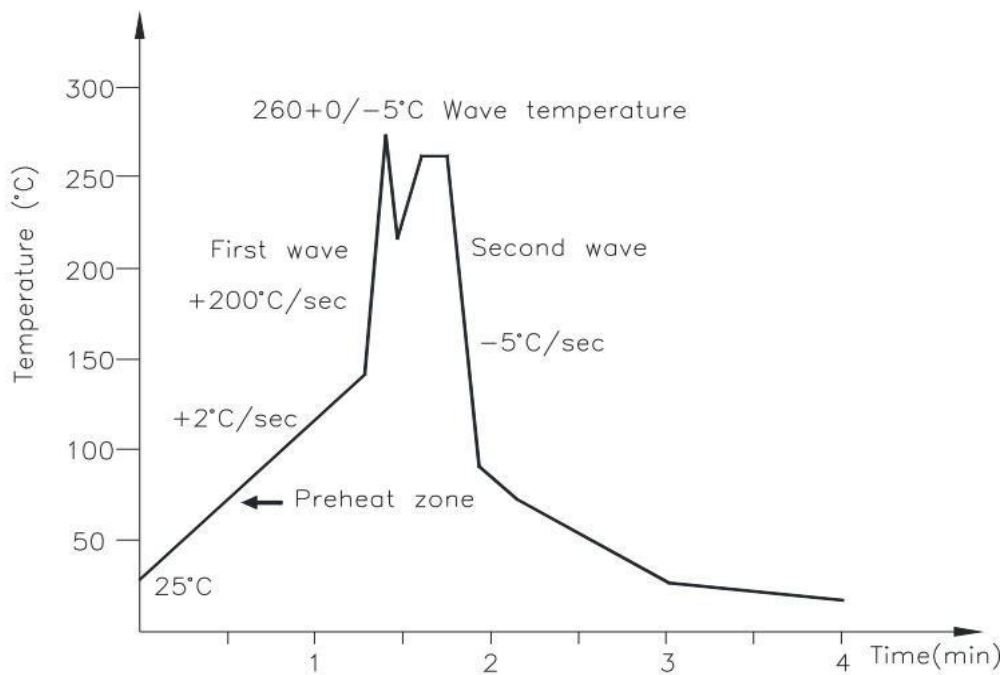

(3).Hand soldering by soldering iron

Allow single lead soldering in every single process. One time soldering is recommended.

Temperature	380+0/-5°C
Time	3 sec max

14. CHARACTERISTICS CURVES (TYPICAL PERFORMANCE)

MAXIMUM FORWARD CURRENT vs. AMBIENT TEMPERATURE

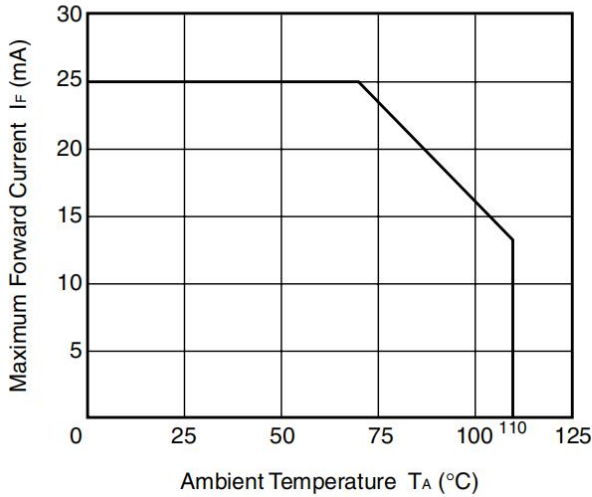

DETECTOR POWER DISSIPATION vs. AMBIENT TEMPERATURE

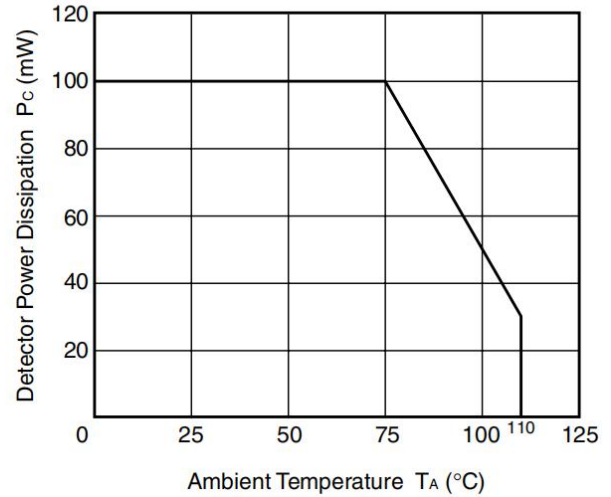

FORWARD CURRENT vs. FORWARD VOLTAGE

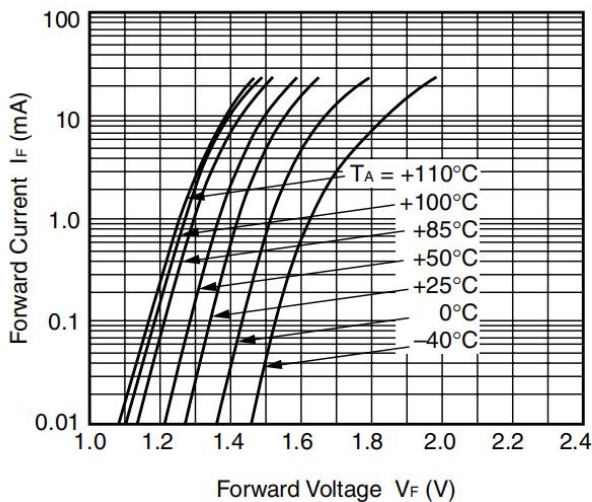

OUTPUT CURRENT vs. OUTPUT VOLTAGE

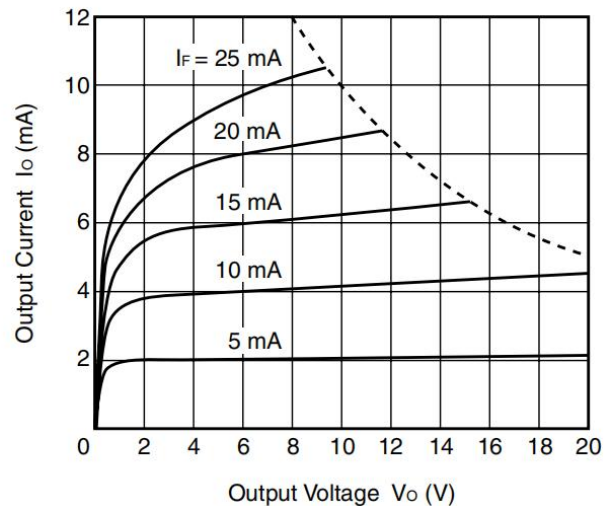

CURRENT TRANSFER RATIO vs. FORWARD CURRENT

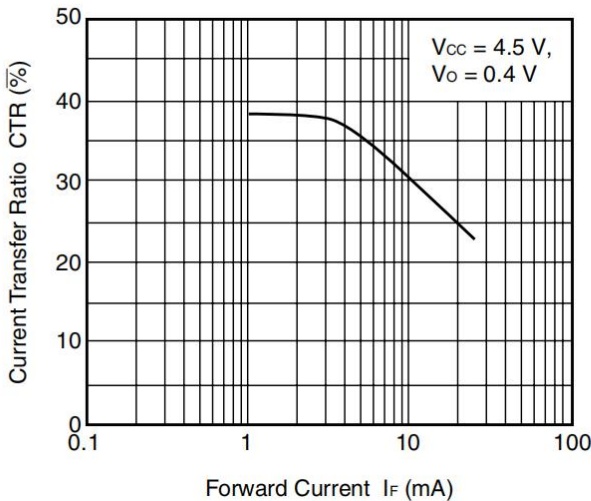

NORMALIZED CURRENT TRANSFER RATIO vs. AMBIENT TEMPERATURE

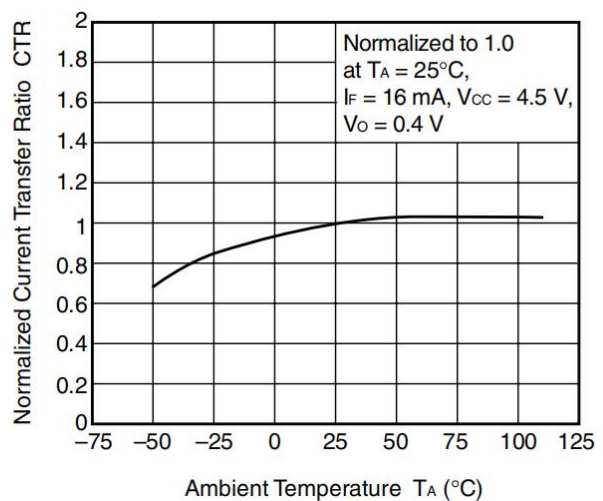

OUTPUT VOLTAGE vs. FORWARD CURRENT

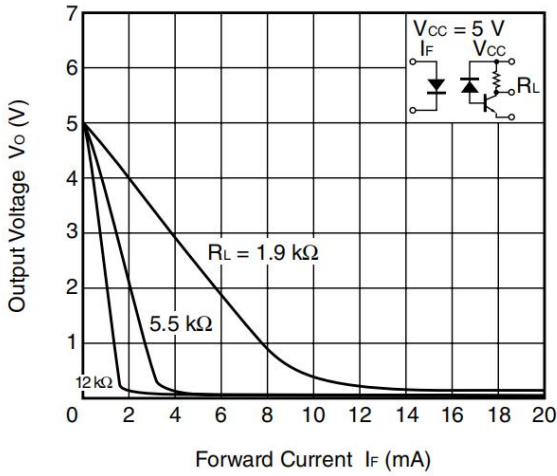

HIGH LEVEL OUTPUT CURRENT vs. AMBIENT TEMPERATURE

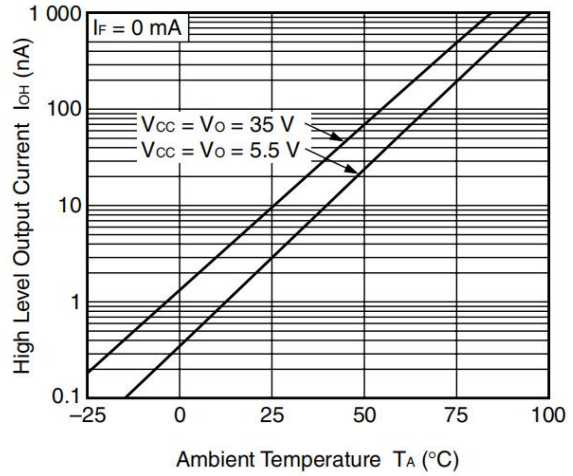

PROPAGATION DELAY TIME, vs. LORD RESISTANCE

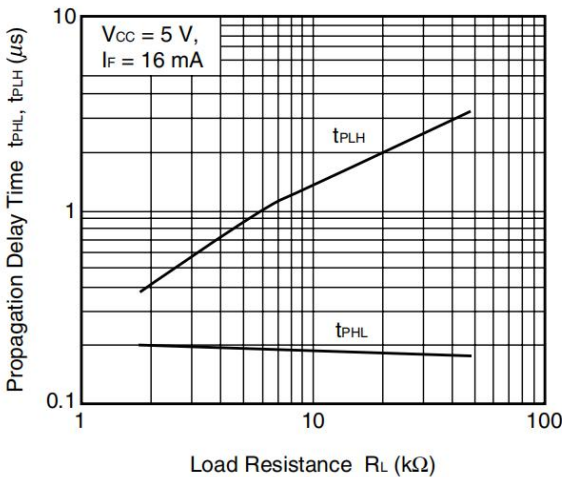

PROPAGATION DELAY TIME, vs. AMBIENT TEMPERATURE

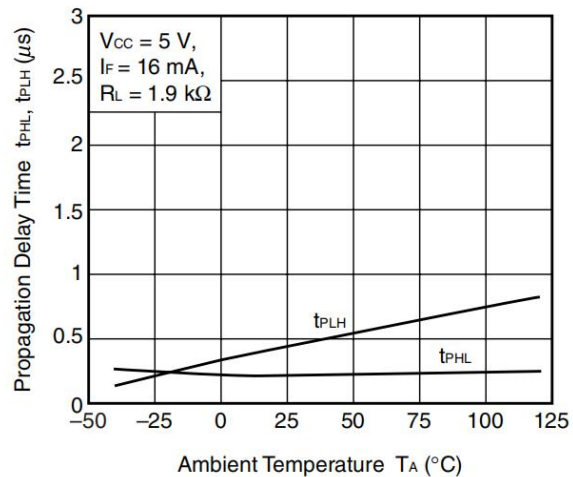

Test circuit for propagation delay time

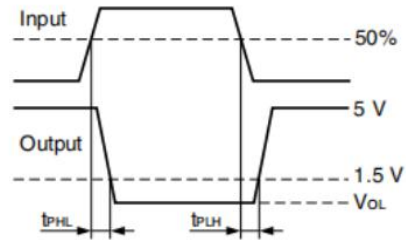
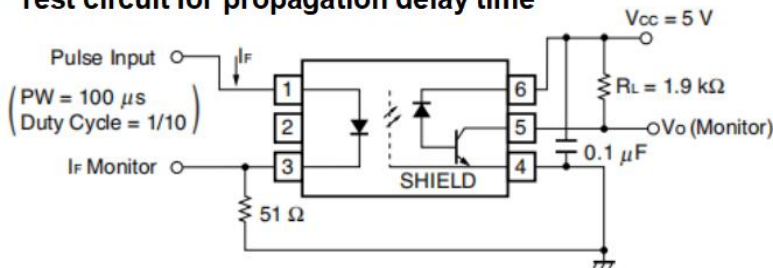

Test circuit for common mode transient immunity

