



ORIENT

Photo MOS

Product Data Sheet

Part Number: OR-M4XXA(X)

Customer: _____

Date: _____

SHENZHEN ORIENT COMPONENTS CO.,LTD.

Block A 3rd Floor No.4 Building, Tian'an Cyber Park, Huangge Rd, LongGang Dist, Shenzhen, GD

TEL: 0755-29681816

FAX: 0755-29681200

www.orient-opto.com

1. Features

- (1) Compliance Halogens Free (Br < 900ppm, Cl < 900ppm, Br+Cl < 1500ppm)
- (2) High input-output isolation voltage ($V_{iso} = 3,750V_{rms}$)
- (3) Small 4pin SOP package in the 400V & 600V load voltage series
- (4) Normally open signal pole signal throw relay
- (5) Low operating current
- (6) Low on resistance
- (7) SOP-4 package
- (8) Operating Temperature -40 °C to 85 °C
- (9) Safety approval
 - UL approved(No.E323844)
 - VDE approved(No.40029733)
 - CQC approved (No.CQC19001231256)
- (10) In compliance with RoHS, REACH standards
- (11) MSL Class I

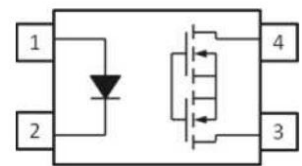

Pin Configuration

1. Anode
2. Cathode
3. 4. MOSFET

2. Instructions

The OR-M4XXA(X) is solid state relays containing an AlGaAs infrared LEDs on the light emitting side (input side) optically coupled to a high voltage output detector circuit. The detector consists of a photovoltaic diode array and MOSFETs on the output side. The single channel configuration is equivalent to 1 form A EMR. The devices in a 4-pin small outline SMD package .

3. Application Range

- (1) Exchange equipment
- (2) Measurement and testing equipment
- (3) FA/OA equipment
- (4) Industrial controls
- (5) Security

4. Max Absolute rated Value (Normal Temperature=25°C)

Parameter		Symbol	Rating				Unit
			OR-M406A	OR-M425A	OR-M440A	OR-M460A	
Input	Forward Current	I _F	50				mA
	Reverse Voltage	V _R	5				V
	Peak Forward Current* ¹	I _{FP}	1				A
	Power Dissipation	P _{in}	75				mW
Output	Break Down Voltage	V _L	60	250	400	600	V
	Continuous Load Current	I _L	550	150	120	50	mA
	Pulse Load Current* ²	I _{LPeak}	1.2	0.5	0.3	0.15	A
	Power Dissipation	P _{out}	500				mW
Total Power Dissipation		P _T	550				mW
Isolation Voltage* ³		V _{iso}	3750				V _{rms}
Storage Temperature		T _{STG}	-40 to 125				°C
Operating Temperature		T _{OPR}	-40 to 85				°C
Soldering Temperature* ⁴		T _{SOL}	260				°C

Notes:

*1. f=100Hz, Duty Cycle = 0.1%

*2. A connection: 100ms (1 shot), V_L = DC

*3. AC for 1 minute, R.H. = 40 ~ 60% R.H. In this test, pins 1, 2 are shorted together, and pins 3, 4 are shorted together.

*4. For 10 seconds

5. Opto-electronic Characteristics

Parameter		Symbol	Min.	Typ.	Max.	Unit	Condition	
Input	Forward Voltage	V_F	---	1.18	1.5	V	$I_F = 10\text{mA}$	
	Reverse Current	I_R	---	---	1	μA	$V_R = 5\text{V}$	
Output	Off State leakage Current		I_{leak}	---	-	1	μA	$I_F = 0\text{mA}, V_L = \text{Max.}$
	On Resistance	OR-M406A	$R_{d(\text{ON})}$	---	0.7	2.5	Ω	$I_F = 10\text{mA}$ $I_L = \text{Max}$ $t = 1\text{s}$
		OR-M425A		---	6.5	15		
		OR-M440A		---	20	30		
		OR-M460A		---	40	70		
	Output Capacitance	OR-M406A	$C_{(\text{out})}$	---	85	---	pF	$V_L = 0\text{V}, f = 1\text{MHz}$
		OR-M425A		---	60	---		
		OR-M440A		---	45	---		
		OR-M460A		---	30	---		
	Transfer Characteristics	LED turn on Current	OR-M406A	$I_{F(\text{on})}$	---	1.25	3	mA
OR-M425A			---		1.18	3		
OR-M440A			---		1.12	3		
OR-M460A			---		1.10	3		
LED turn off Current		OR-M406A	$I_{F(\text{off})}$	0.2	0.65	---	mA	$I_L = 1\mu\text{A.}$
		OR-M425A		0.2	0.63	---		
		OR-M440A		0.2	0.62	---		
		OR-M460A		0.2	0.60	---		
Turn On Time		OR-M406A	T_{on}	---	0.25	0.5	ms	$I_F = 10\text{mA}$ $I_L = \text{Max,}$ $R_L = 200\Omega$
		OR-M425A		---	0.25	0.5		
		OR-M440A		---	0.25	0.5		
		OR-M460A		---	0.25	0.5		
Turn Off Time		OR-M406A	T_{off}	---	0.08	0.5	ms	$I_F = 10\text{mA}$ $I_L = \text{Max,}$ $R_L = 200\Omega$
		OR-M425A		---	0.08	0.5		
		OR-M440A		---	0.07	0.5		
		OR-M460A		---	0.05	0.5		
Isolation Resistance		R_{I-O}	5×10^{10}	---	---	Ω	$V_{I-O} = 500\text{V DC}$	
Isolation Capacitance		C_{I-O}	---	1.5	---	pF	$V = 0\text{V}, f = 1\text{MHz}$	

6. Load Current Rank

Parameter	Symbol	Rating			Condition
		M406A		M440A	
		(A)	(B)	(A)	
Break Down Voltage	V_L	60V	60V	400V	
Continuous Load Current	I_L	1A	0.55A	0.12A	Peak AC, DC
Pulse Load Current*2	I_{LPeak}	3A	1.5A	0.3A	100 ms (1 shot), $V_L = DC$

7. Order Information

Part Number

OR-M4XXA(X)-W-Y-Z

Note

M4XXA(X) = Part Number (XX for 06, 25, 40 or 60, X for A,B,C)

W = Tape and reel option (TP or TP1).

Y = 'V' code for VDE safety (This options is not necessary).

Z = 'G' code for Halogen free.

* VDE Code can be selected.

Option	Description	Packing quantity
TP	Surface mount lead form (low profile) + TP tape & reel option	3000 units per reel
TP1	Surface mount lead form (low profile) + TP1 tape & reel option	3000 units per reel

8. Naming Rule

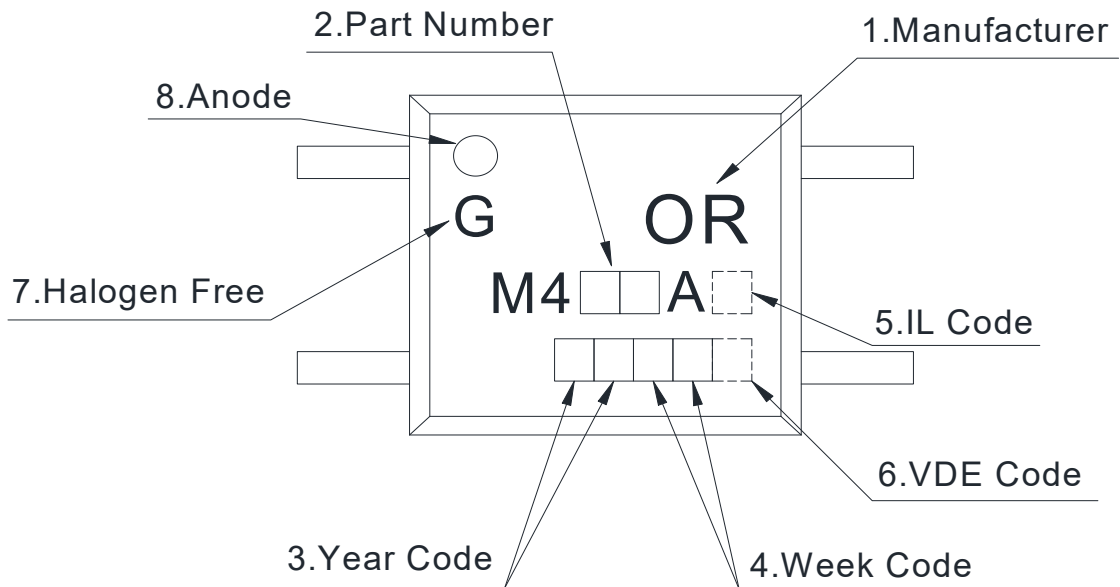

1. Manufacturer : ORIENT.
2. Part Number : M4XXA(X).
3. Year Code : '21' means '2021' and so on.
4. Week Code : 01 means the first week, 02 means the second week and so on.
5. IL Code . (Optional)
6. VDE Code . (Optional)
7. HF Code G : Halogen Free.
8. Anode.

* VDE Mark can be selected.

9. Outer Dimension

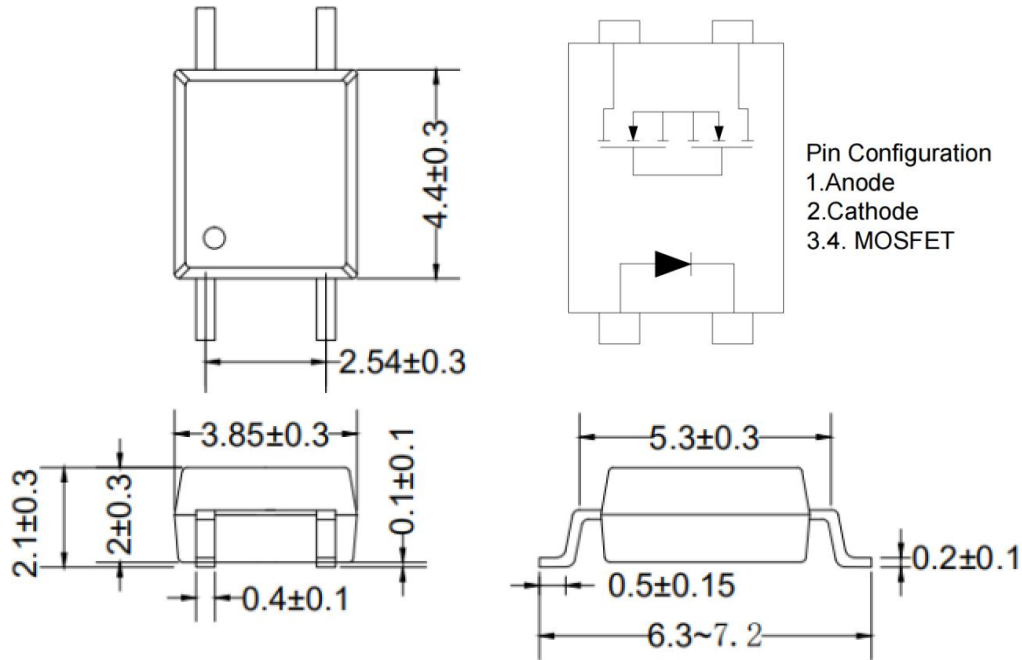

10. Recommended Foot Print Patterns (Mount Pad)

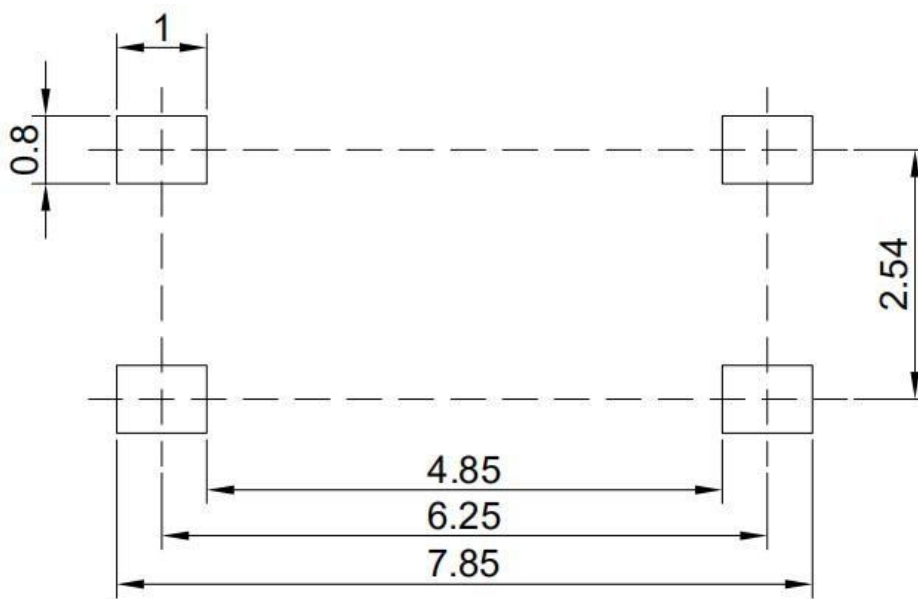

unit: mm

11. Taping Dimensions

(1) OR-M4XXA(X)-TP

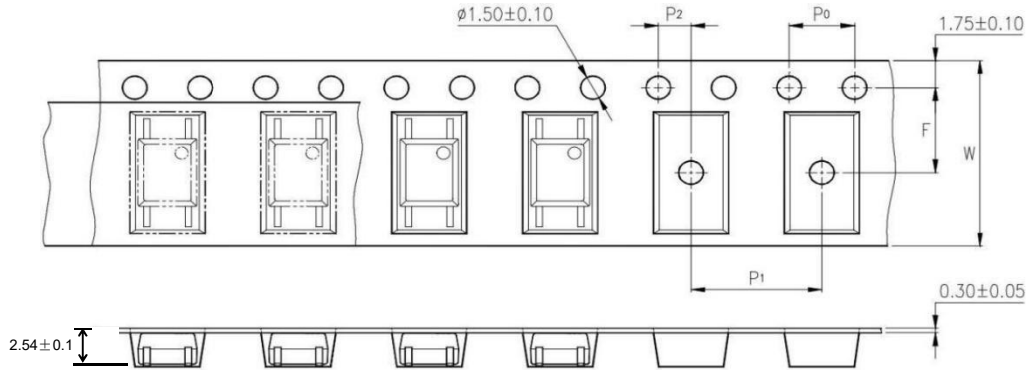

(2) OR-M4XXA(X)-TP1

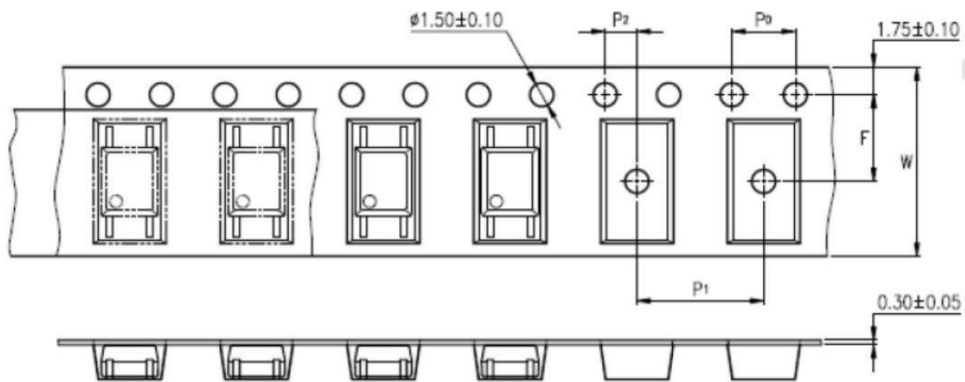

Description	Symbol	Dimension in mm(inch)
Tape wide	W	12±0.3 (0.472)
Pitch of sprocket holes	P0	4±0.1 (0.157)
Distance of compartment	F	5.5±0.1 (0.217)
	P2	2±0.1 (0.079)
Distance of compartment to compartment	P1	8±0.1 (0.315)

Package Type	TP/TP1
Quantities(pcs)	3000

12. Package Dimension

(1) package dimension

Packing Information	
Packing type	Reel type
Tape Width	12mm
Qty per Reel	3,000pcs
Small box (inner) Dimension	345*345*45mm
Large box (Outer) Dimension	480x360x360mm
Max qty per small box	6,000pcs
Max qty per large box	60,000pcs

(2)Packing Label Sample



Material Code : 120PCXXXXXX
|||||
P/N : OR-XXXXXX
|||||
Lot No. : XXXXXX-XXXXX-TX-X
|||||
D/C : XXXX
|||||
Qty : XXXX PCS
|||||





内箱码

外箱码

“XXXXXXXXXXXXXXXXXX” (一体机序列码)

Made in China

Note:

1. Material Code :Product ID.
2. P/N :Contents with "Order Information" in the specification.
3. Lot No. :Product data.
4. D/C :Product weeks.
5. Quantity :Packaging quantity.

13. Temperature Profile Of Soldering

(1) IR Reflow soldering (JEDEC-STD-020C compliant)

One time soldering reflow is recommended within the condition of temperature and time profile shown below.
Do not solder more than three times.

Profile item	Conditions
Preheat	
- Temperature Min (T Smin)	150°C
- Temperature Max (T Smax)	200°C
- Time (min to max) (ts)	90±30 sec
Soldering zone	
- Temperature (TL)	217°C
- Time (t L)	60 sec
Peak Temperature	260°C
Peak Temperature time	20 sec
Ramp-up rate	3°C / sec max.
Ramp-down rate from peak temperature	3~6°C / sec
Reflow times	≤3

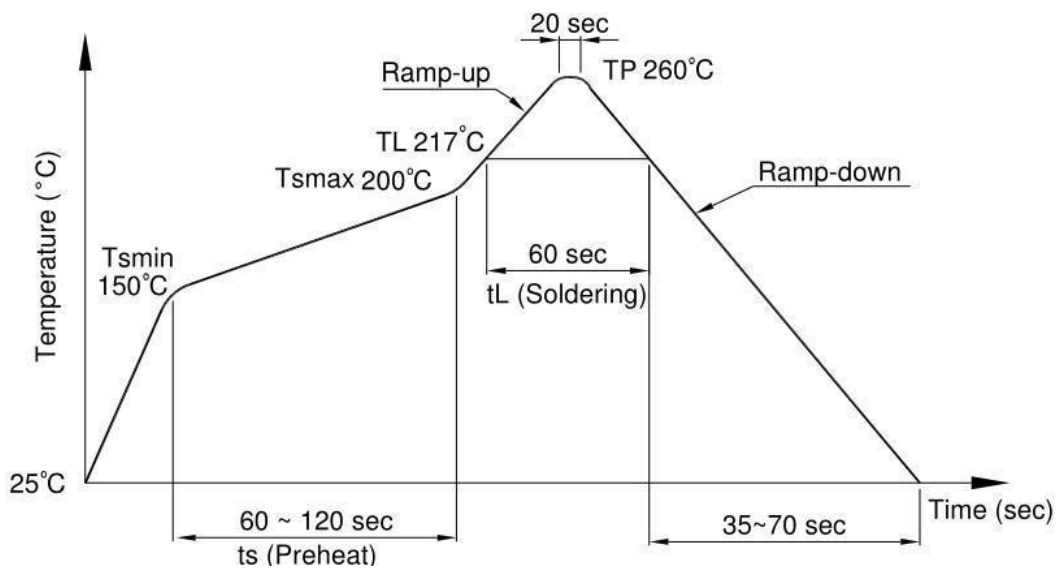

(2) Wave soldering (JEDEC22A111 compliant)

One time soldering is recommended within the condition of temperature.

Temperature	260+0/-5°C
Time	10 sec
Preheat temperature	5 to 140°C
Preheat time	30 to 80 sec

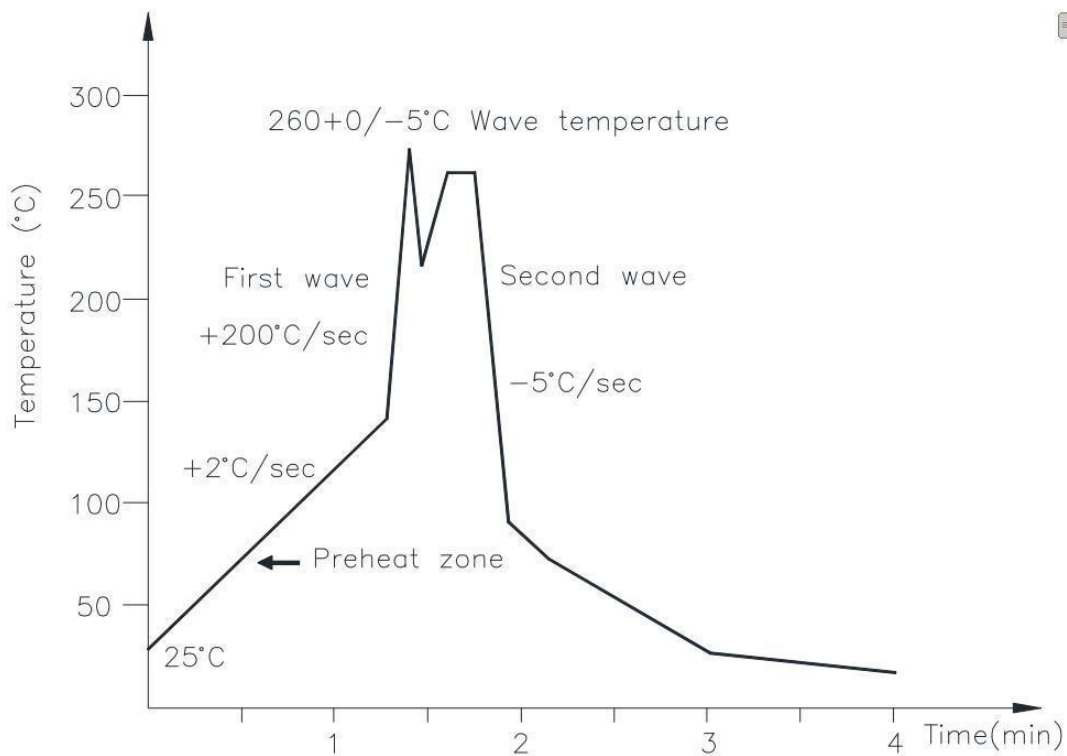

(3) Hand soldering by soldering iron

Allow single lead soldering in every single process. One time soldering is recommended.

Temperature	380+0/-5°C
Time	3 sec max

14. Characteristics Curve

Figure 1. Load current vs Ambient temperature

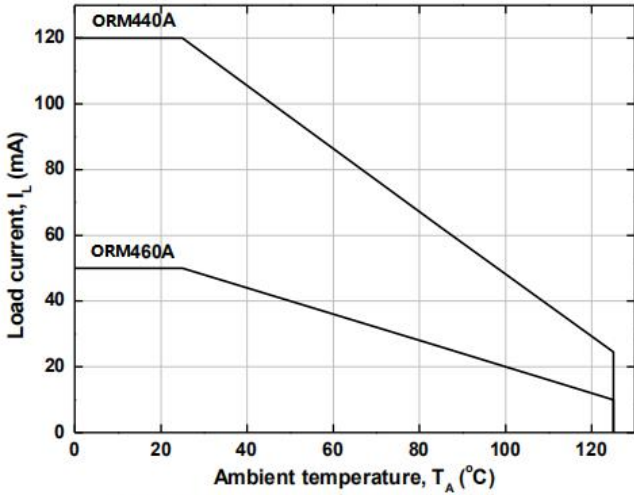

Figure 2. On Resistance vs Ambient Temperature

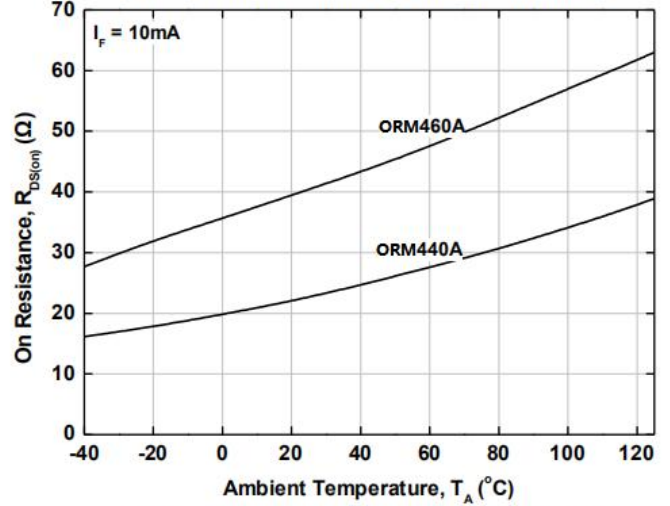

Figure 3. Switching Time vs Ambient Temperature

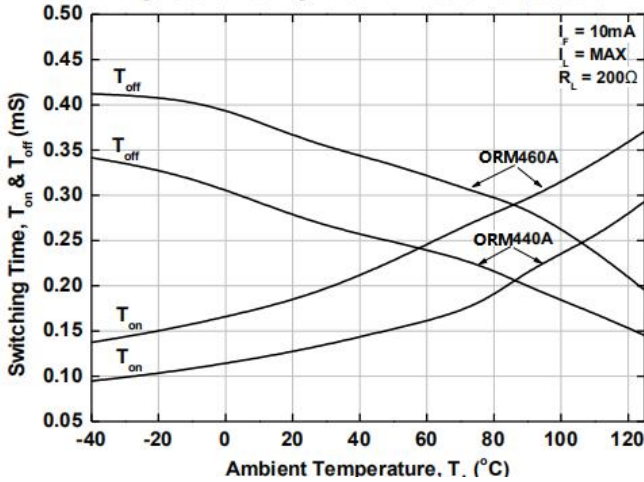

Figure 4. Switching time vs LED forward current

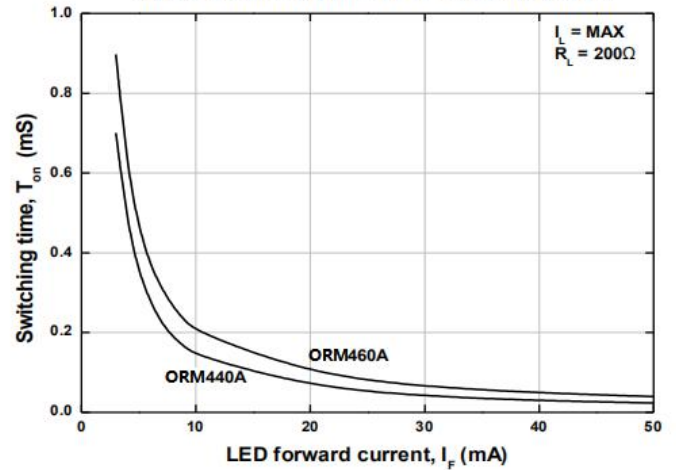

Figure 5. Switching time vs LED forward current

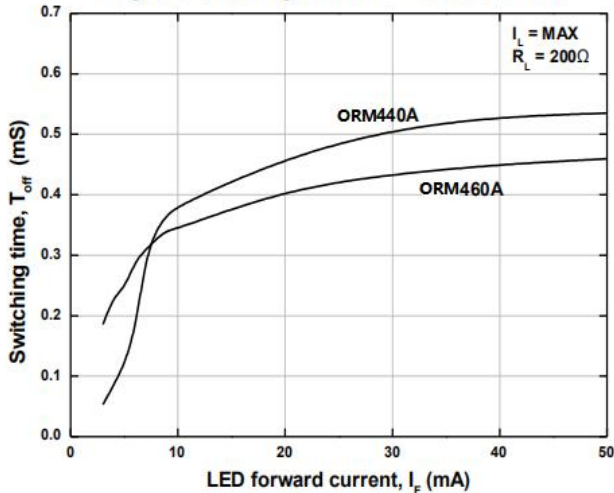

Figure 6. Normalized LED Operate on Current vs Ambient Temperature

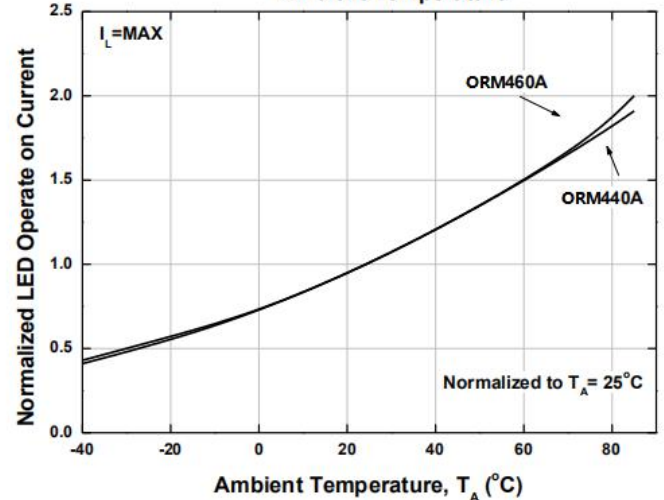

Figure 7. Normalized LED Operate off Current vs Ambient Temperature

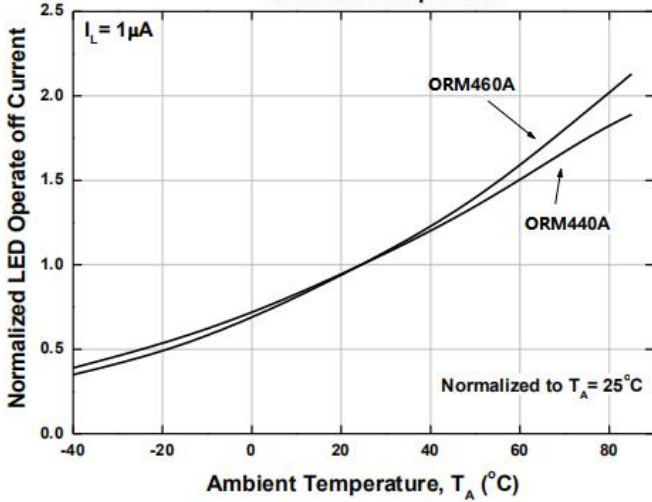

Figure 8. LED Dropout Voltage vs Ambient Temperature

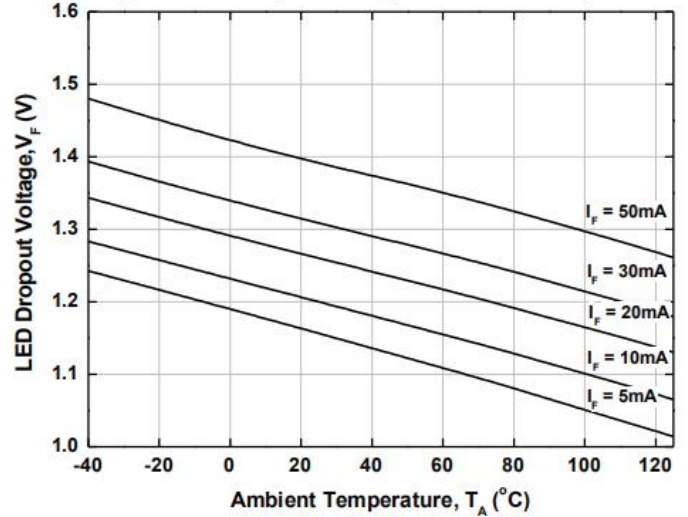

Figure 9. Load voltage vs Load current

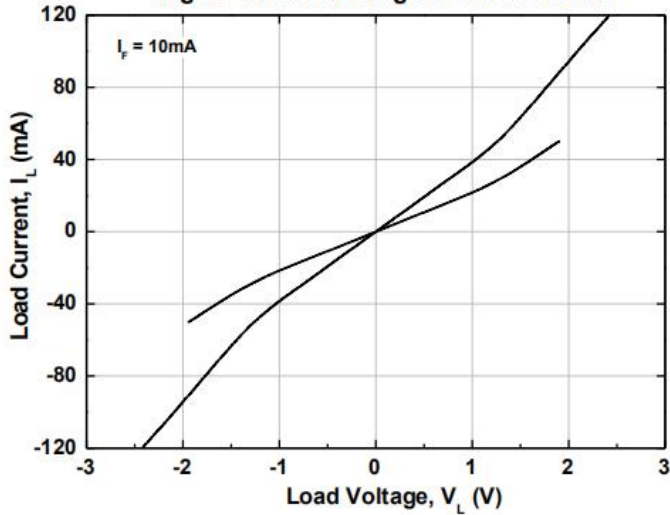

Figure 10. Off state leakage Current vs Load voltage

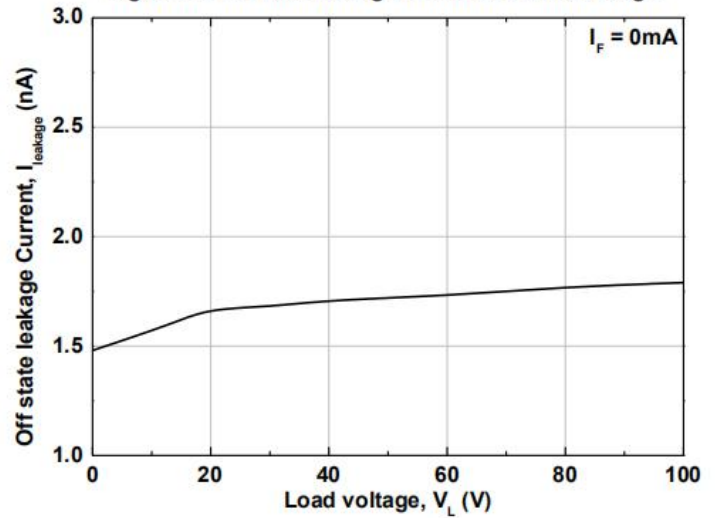
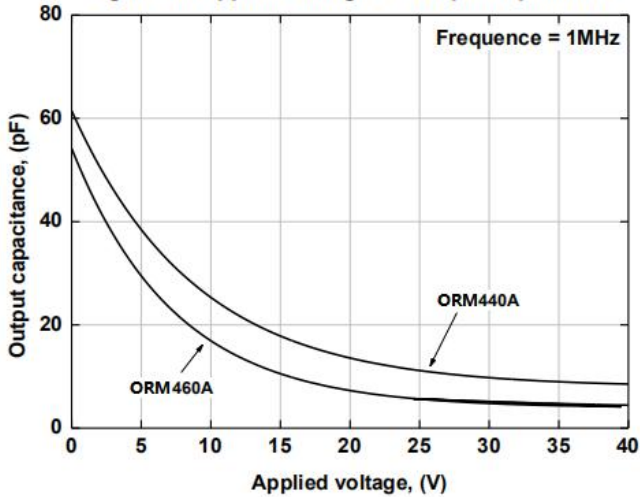

Figure 11. Applied voltage VS Output capacitance



Turn on/Turn off Time

