



SPECIFICATION

Customer Name					
Customer No.					
Product Description			Photo Interrupter		
Product Model			ORTR-8307-L24-1T		
Orient Confirm			Customer Confirm		
Approved by	Checked by	Prepared by	Approved by	Quality	Engineering
Linshixiu	Huanghaijun	Sushiheng			
Judge outcome:		OK	Judge outcome:		



静电敏感元件



Add: Block A 3rd Floor No.4 Building, Tian'an Cyber Park, Huangge Rd,
 LongGang Dist, Shenzhen, GD
 TEL: 0755-29681816 FAX: 0755-29681200
 URL: www.orient-opto.com



1、 Features

- Fast response time.
- High sensitivity.
- Cut-Off visible wavelength.
- Thin.
- Compact.
- Pb free.
- This product itself will remain within RoHS compliant version.



2、 Applications

- Camera.
- VCR.
- Floppy disk driver.
- Cassette type recorder.
- Various microcomputer control equipment.

3. Descriptions:

ORTR-8307 is a light reflection switch which includes a GaAs IR-LED transmitter and a NPN photo-transistor with a high photosensitive receiver for short distance, operating in the infrared range. Both components are mounted side-by-side in a plastic package.

4. Device Selection Guide:

DeviceNo.	ChipMaterial
IR	GaAs
PT	Silicon

5、 Package Outline Dimensions

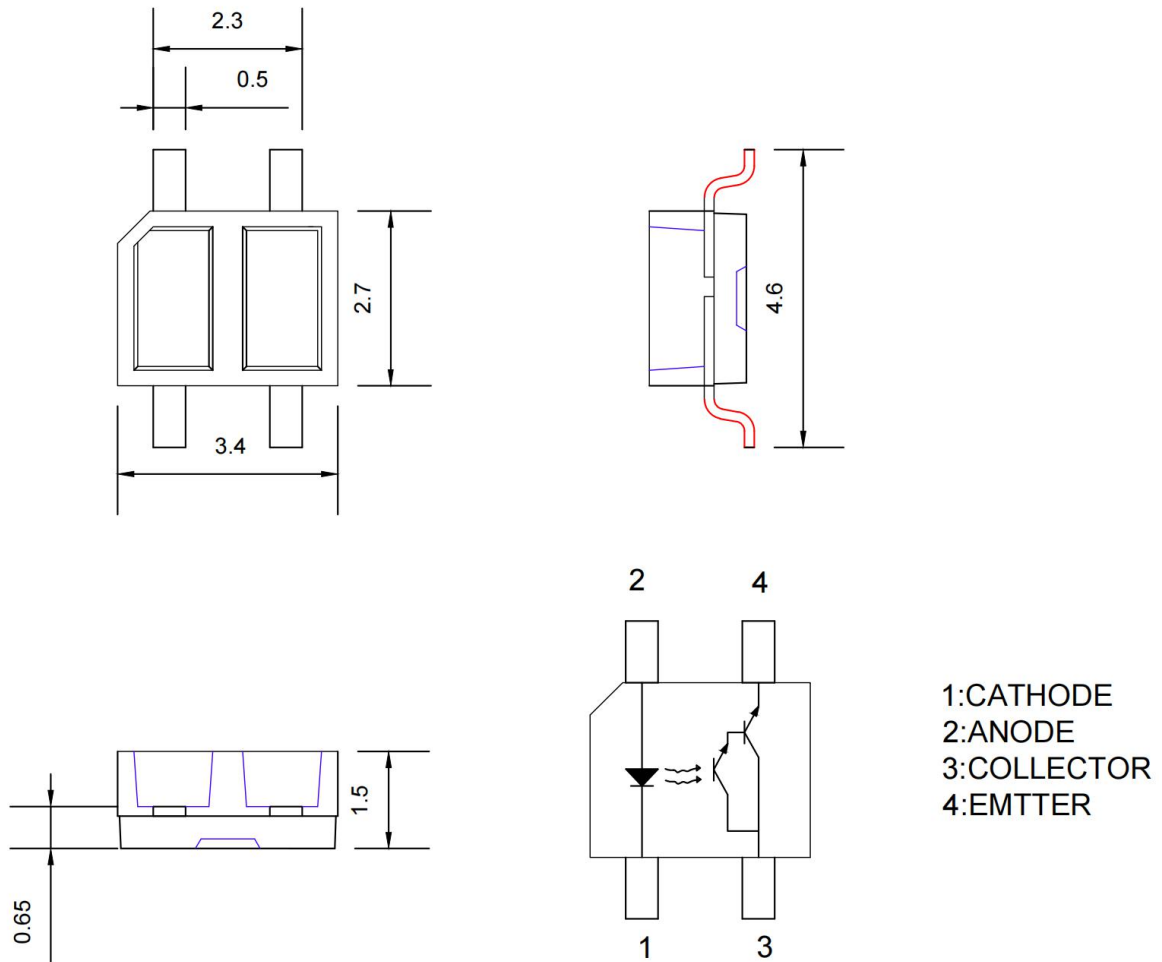

Notes:

- 1). All dimensions are in millimeters (inches).
- 2). Tolerance is $\pm 0.15\text{mm}$ unless otherwise specified.
- 3). Specifications are subject to change without notice.



6、 Absolute maximum ratings at Ta=25°C

	Parameter	Symbol	Rating	Unit
Input	Power Dissipation	Pd	75	mW
	Forward Current	I _F	50	mA
	Peak Forward Current * 1	I _{FP}	1	A
	Reverse Volage	V _R	5	V
Ouput	CollectorPower Dissipation	P _C	100	mW
	Collector Current	I _C	50	mA
	C-E Voltage	V _{CEO}	30	V
	E-C Voltage	V _{ECO}	5	V
Operating Temperature Range		T _{opr}	-40~+85	°C
Storage Temperature Range		T _{stg}	-40~+100	°C
Soldering Temperature		T _{slid}	Reflow Soldering:260°C ≤ 10secs	

(*1)tw=100 uSec.、 T=10 mSec.



7、Electrical-optical characteristics at Ta=25°C

	Parameter	Condition	Symbol	Min.	Typ.	Max.	Unit
Input	Forward Voltage	V_F	$I_F=20mA$	-	1.2	1.6	V
	Peak Wavelength	λ_p	$I_F=10mA$		940		nm
	Reverse Current	I_R	$V_R=5V$	-	-	10	μA
Output	Dark Current	I_D	$V_{CE}=10V$	-	-	100	nA
	C-E Saturation Voltage	$V_{CE(sat)}$	$I_C=2mA$ $E_e=1mW/cm^2$	-	-	1	V
	Light Current	I_L	$V_{CE}=2V$ $I_F=4mA$	0.5	-	15	mA
	Leakage Current	I_{CEOD}	$V_{CE}=2V$ $I_F=4mA$	-	-	5	μA
Speed	Rise Time	T_r	$I_c=0.1mA$ $V_{CE}=2V$	-	20	-	μsec
	Fall Time	T_f	$R_L=1000\Omega$, $d=1mm$	-	20	-	μsec

Notes:

- 1、Tolerance of Light Current is $\pm 10\%$.
- 2、Tolerance of forward voltage is $\pm 0.1V$.

8. Typical optical characteristics curves

Fig.1 Power Dissipation vs. Ambient Temperature

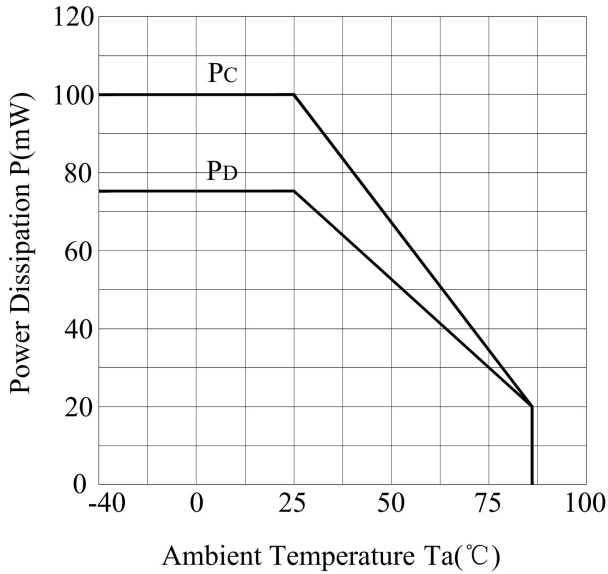

Fig.2 Forward Current vs. Forward Voltage

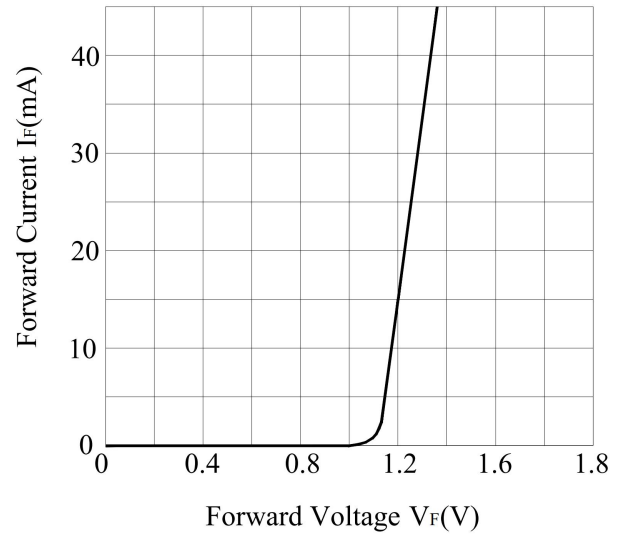

Fig.3 Collector Current vs. Collector-emitter Voltage

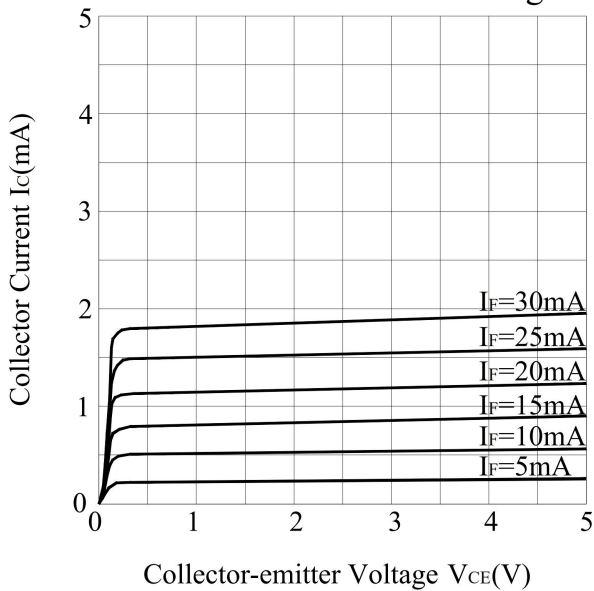

Fig.4 Collector Current vs. Ambient Temperature

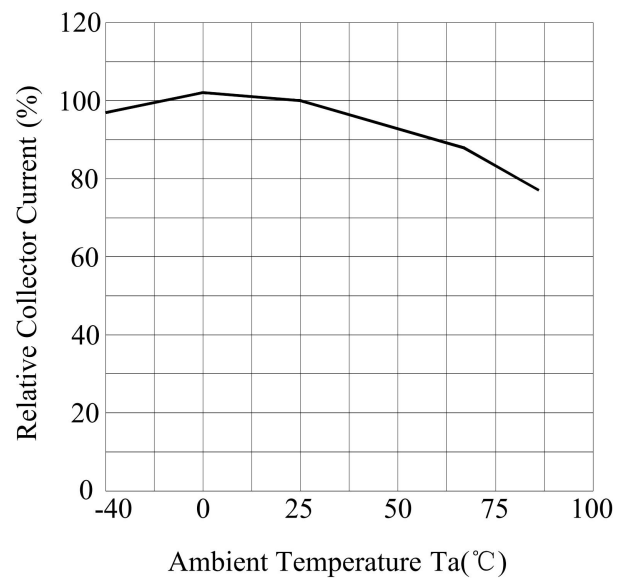

Fig.5 Collector-emitter Saturation Voltage vs. Ambient Temperature

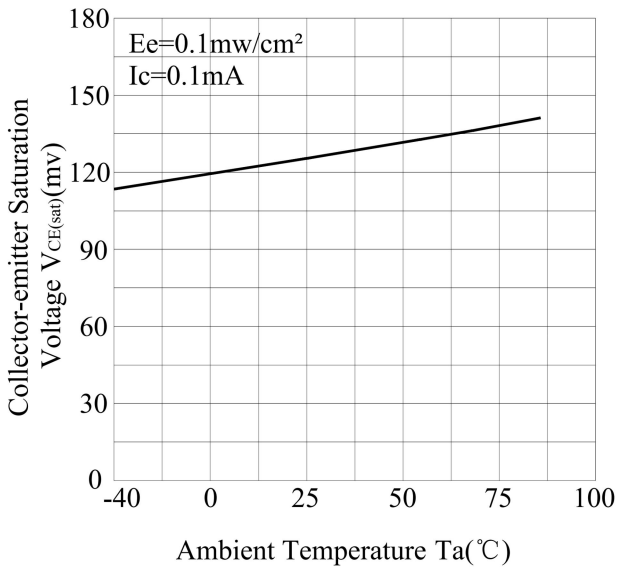

Fig.6 Response Time vs. Load Resistance

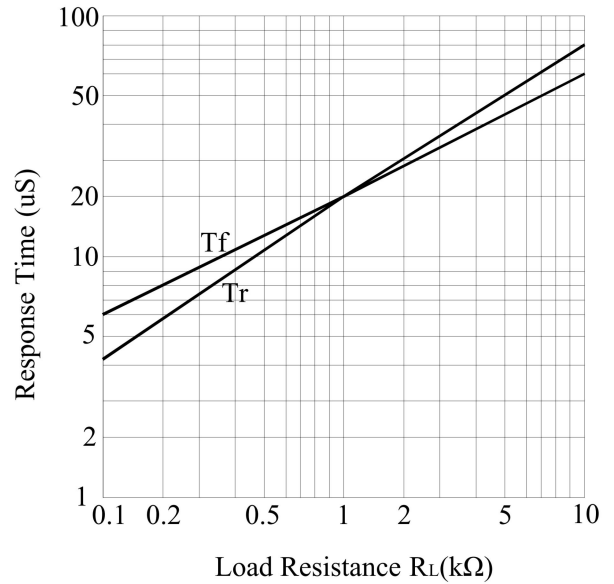

Fig.7 Sensing Position Characteristics (Typical)

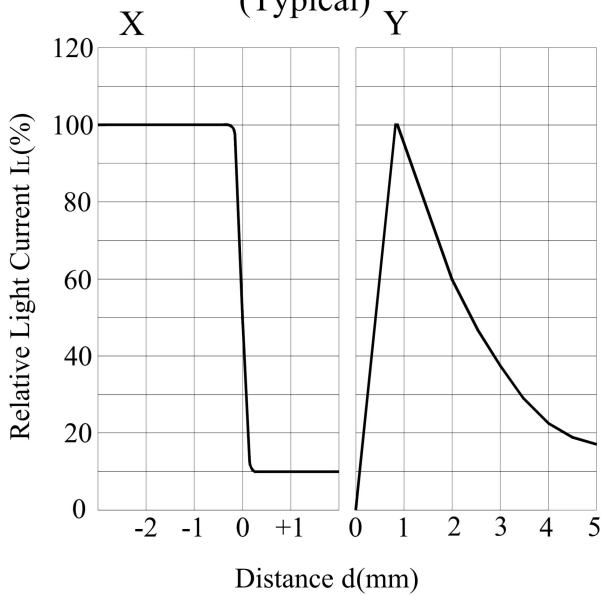
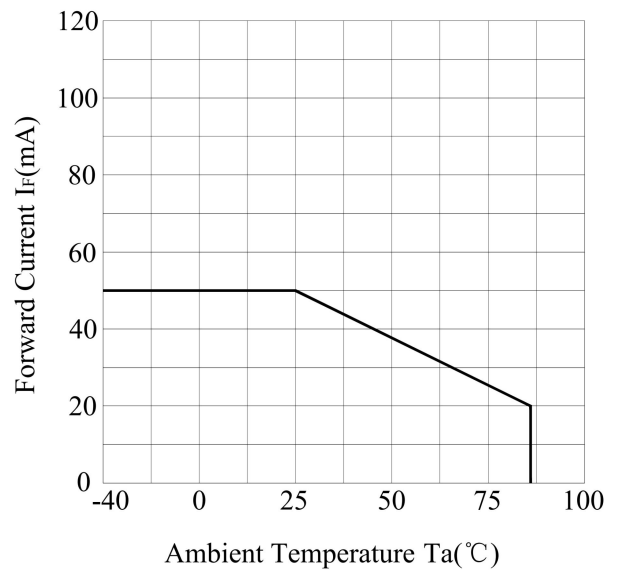
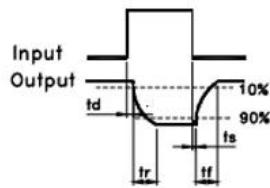
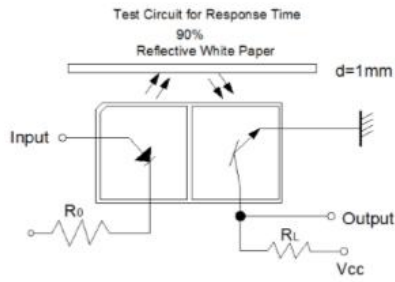

Fig.8 Forward Current Derating Curve vs. Ambient Temperature



Test Circuit for Response Time



(Center of Optical axis)

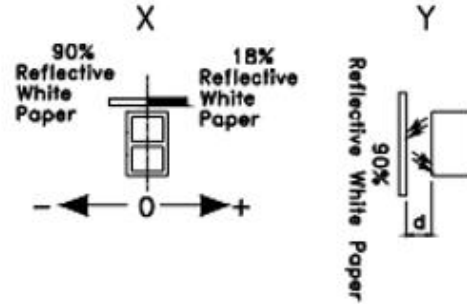

9、Packaging Specification

- Dimensions for Reel (Unit: mm)

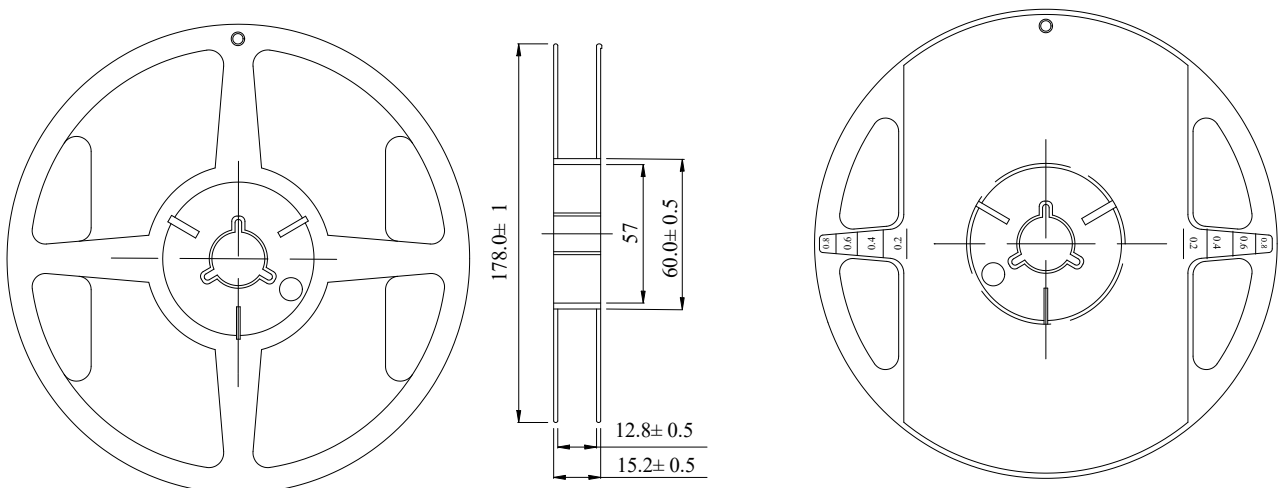

●Dimensions of Tape (Unit: mm)

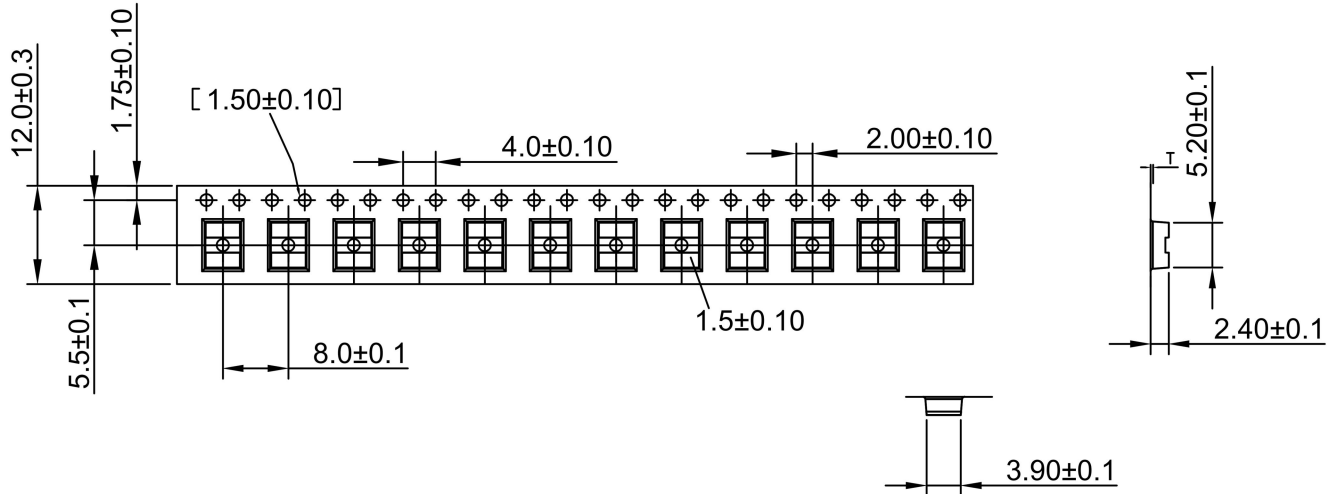

Notes:

- 1、 All dimensions are in mm, tolerance is ± 0.1 mm unless otherwise noted.
- 2、 Specifications are subject to change without notice.
- 3、 Loaded quantity: 1000 pcs/reel.

●Package Method: Vacuum (Unit: mm)

50bag/box

1000pcs/bag

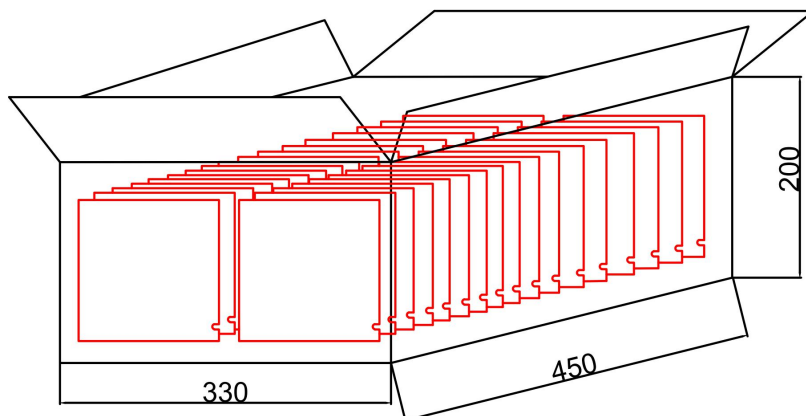



10、Label description

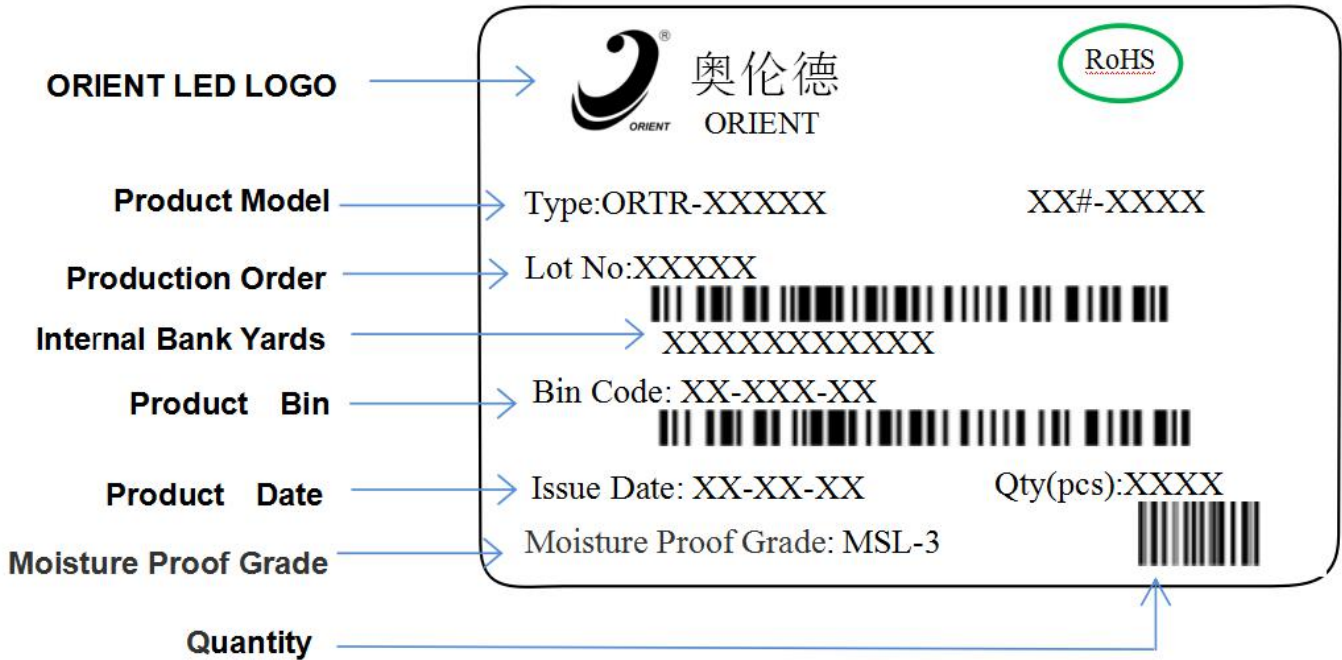

11、Precautions for use

1、Soldering

SMD LED encapsulation is very flexible, outside force easily demolish radiant surface and plastic, As soldering, Please handle with care!

1.1. With No-clean Flux, according to reflow soldering cure condition when soldering, Reflow soldering should not be done more than two times, simultaneity you must insure clean on the radiant surface. Otherwise, foreign objects can affect radiant color.

1.2. Don't process manual soldering except repair. Recommended to be soldered with 25W Anti-static iron, The temp. of the iron should be lower than 300°C and soldering time should not be done more than three seconds, at the same time iron can't touch radiant surface and plastic.

1.3. Don't twist LED in course of manual soldering and experiment, otherwise, the lights will not work possibly.

1.4. Please use the same BIN grade in one panel, and don't mix the difference BIN grade in one panel when soldering. Otherwise, it will cause a serious uneven color problem.

1.5. Please control the sulfur content of solder paste and PCB.

1.6. Pb-free solder temp.-time profile as below:260°C Max

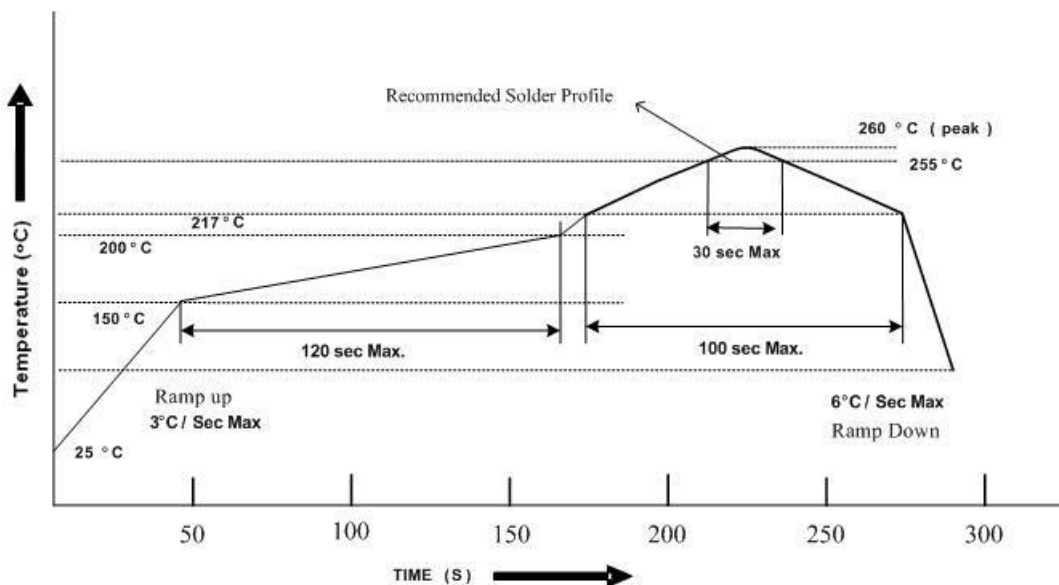

2、Cleaning

2.1. Don't be cleaned with ultrasonic. Recommended to be wiped with isopropyl alcohol or pure alcohol, wiping time should not be more than one minute. LED must be placed at room temperature for fifteen minutes before using. After cleaning, you must insure clean on the radiant surface. Otherwise, foreign objects can affect radiant color.

2.2. LED can not be in contact with isoamyl acetate, trichloroethylene, acetone, sulfide, nitride, acid, alkali, salt. These matter can destroy LED.

3、Sealing

3.1. Sealing glue can not contain sodium ion, sulfide, because these matter can affect fluorescence powder poisoning.

3.2. When using normal sealing glue, Use within 168 hours after opening



4、Storage

- 4.1. Don't open the moisture proof bag before ready to use the LEDs.
- 4.2. The LEDs should be kept at 30°C or less and 60%RH or less before opening the package. The max. storage period before opening the package is 1 year.
- 4.3. After opening the package, the LEDs should be kept at 30-35%RH or less, and it should be used within 3 days. If the LEDs should be kept at 30-35%RH or more, and it should be used within 4 hours.
- 4.4. If the LEDs be kept over the conditions of 20%, baking is required before mounting. Baking condition as below: 70±5°C for 12 hrs for bulk goods, 105±5°C for 1 hrs for roll goods.
- 4.5. The environment have no acid, alkali, corrosive gas, intensively shake and high magnetic field.

5、Static

- 5.1. Static and Peak surge voltage can destroy LED, Avoiding Instantaneous voltage when turn on or turn off the lights.
- 5.2. Please wear Anti-static wrist band, Anti-static glove, Anti-static shoes in the course of operation, and the equipment must be grounded.

6、Test

- 6.1. Customer must apply the current limiting resistor in the circuit so as to drive the LEDs within the rated current. Otherwise slight voltage shift maybe will cause big current change and burn out will happen.
- 6.2. Also, caution should be taken not to overload the LEDs with instantaneous high voltage at the turning ON and OFF of the circuit. Otherwise, The LEDs will be destroyed, testing methods as follows:
- 6.3. The reverse voltage mustn't exceed 5v when lighting on or testing the LED, otherwise, The LEDs will be damaged.

7、Else

Radiant color of LEDs have a little change with the current, recommended that LED is used in series and resistance, when lighting, please don't see directly radiant surface of LED, otherwise LED will burn eyes.