



# ORIENT

## Photo coupler

### Product Data Sheet

MPN: OR-354 series of GK

Customer: \_\_\_\_\_

Date: \_\_\_\_\_

**SHENZHEN ORIENT COMPONENTS CO.,LTD.**

Block A 3rd Floor No.4 Building, Tian'an Cyber Park, Huangge Rd, LongGang Dist, Shenzhen, GD

TEL: 0755-29681816

FAX: 0755-29681200

[www.orient-opto.com](http://www.orient-opto.com)

**Preliminary**

This datasheet is a preliminary design specification, and the formal specifications are subject to the recognition letter with jointly signed

## 1. Features

- (1) Current transfer ratio(CTR : MIN. 20% at  $I_F = \pm 1\text{mA}$ ,  $V_{CE} = 5\text{V}$ ,  $T_a = 25^\circ\text{C}$ )
- (2) High input -output isolation voltage (  $V_{ISO} = 3,750\text{V}_{rms}$  )
- (3) High collector-emitter voltage (  $V_{CEO} = 80\text{V}$  )
- (4) SOP-4 package
- (5) Operating Temperature  $-55^\circ\text{C}$  to  $125^\circ\text{C}$
- (6) ESD pass HBM 8000V/MM 2000V
- (7) Safety approval
  - UL approved(No.E323844)
  - VDE approved(No.40029733)
  - CQC approved (No.CQC19001231256)
- (8) In compliance with RoHS, REACH standards
- (9) MSL Class I



## 2. Instruction

- The OR-354-(GK) series device consists of two infrared emitting diode, connected in inverse parallel, optically coupled to a photo transistor detector. They are encapsulated in a 4 pin SOP encapsulation.
- Pin pitch of OR-354 is 2.54mm

## 3. Application Range

- (1) Hybrid substrates that require high density mounting.
- (2) Programmable controllers
- (3) System appliance, measuring instruments

## 4. Functional Diagram

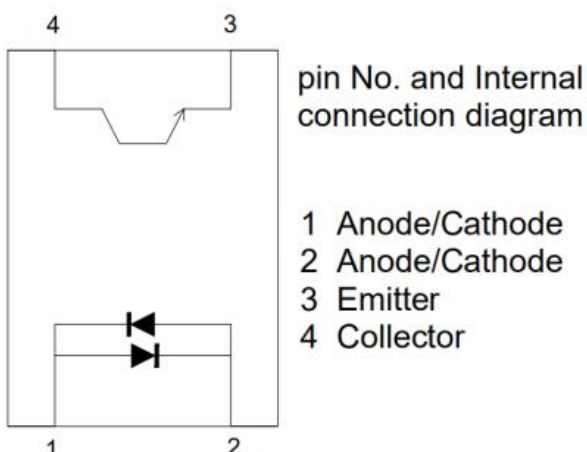

**5. Max Absolute rated Value (Normal Temperature=25°C)**

Parameter		Symbol	Rated Value	Unit
Input	Forward Current	$I_F$	±50	mA
	Junction Temperature	$T_J$	125	°C
	Consume Power	P	70	mW
Output	Collector and emitter Voltage	$V_{CEO}$	80	V
	Emitter and collector Voltage	$V_{ECO}$	7	
	Collector Current	$I_C$	50	mA
	Consume Power	$P_C$	150	mW
	Junction Voltage	$T_J$	125	°C
Total Consume Power		$P_{tot}$	170	mW
*1 Insulation Voltage		$V_{iso}$	3750	V <sub>rms</sub>
Operation Temperature		$T_{opr}$	-55 to + 125	°C
Storage Temperature		$T_{stg}$	-55 to + 150	
*2 Soldering Temperature		$T_{sol}$	260	

\*1. AC Test, 1 minute, humidity = 40~60% Insulation test method as below:

- (1) Short circuit both terminals of photo coupler.
- (2) No Current when testing insulation voltage.
- (3) Adding sine wave voltage when testing.

\*2. soldering time is 10 seconds.

## 6. Opto-electronic Characteristics

Parameter		Symbol	Min	Typ.*	Max	Unit	Condition
Input	Forward Voltage	$V_F$	---	1.2	1.4	V	$I_F = \pm 20\text{mA}$
	Terminal capacitance	$C_t$	---	30	250	pF	$V=0, f=1\text{KHz}$
Output	Collector to emitter Current	$I_{CEO}$	---	---	100	nA	$V_{CE}=20\text{V}, I_F=0\text{mA}$
	Collector-Emitter Breakdown Voltage	$BV_{CEO}$	80	---	---	V	$I_C=0.1\text{mA}, I_F=0\text{mA}$
	Emitter-Collector Breakdown Voltage	$BV_{ECO}$	7	---	---	V	$I_E=0.1\text{mA}, I_F=0\text{mA}$
	*1 Current Transfer Ratio	CTR	20	---	400	%	$I_F = \pm 1\text{mA}$ $V_{CE}=5\text{V}$
	Collector Current	$I_C$	0.2	---	4	mA	
	Collector and Emitter Saturation Voltage	$V_{CE(sat)}$	---	---	0.2	V	$I_F = \pm 20\text{mA}$ $I_C = 1\text{mA}$
	Insulation Impedance	$R_{iso}$	$5 \times 10^{10}$	$1 \times 10^{11}$	---	$\Omega$	DC500V 40~60%R.H.
	Floating Capacitance	$C_f$	---	0.6	1	pF	$V=0, f=1\text{MHz}$
	Rise Time	$t_r$	---	2.9	10	$\mu\text{s}$	$V_{CC}=2\text{V}, I_C=2\text{mA}, R_L=100\Omega$
	Fall Time	$t_f$	---	4.5	10	$\mu\text{s}$	

- Current Conversion Ratio =  $I_C / I_F \times 100\%$

## 7. Rank table of current transfer ratio CTR

CTR Rank	Min.	Max.	Condition	Unit
A	50	150	I <sub>F</sub> =±1mA, V <sub>CE</sub> =5V, Ta=25°C	%
B	80	400		
B2	100	400		
C	100	200		
No mark	20	400		
GR	100	300	I <sub>F</sub> =±5mA, V <sub>CE</sub> =5V, Ta=25°C	

\*

Current Conversion Ratio =  $I_C / I_F \times 100\%$

## 8. Order Information

**Part Number**

**OR-354X-W-Y-Z-(GK)**

**Note**

X = CTR Rank (A, B, B2, C,GR or none)  
W = Tape and reel option ( TP or TP1).  
Y = 'V' code for VDE safety (This options is not necessary).  
Z = 'G' code for Halogen free.  
GK = Field Code.

\* VDE Code can be selected.

Option	Description	Packing quantity
TP	Surface mount lead form (low profile) + TP tape & reel option	3000 units per reel
TP1	Surface mount lead form (low profile) + TP1 tape & reel option	3000 units per reel

## 9. Naming Rule

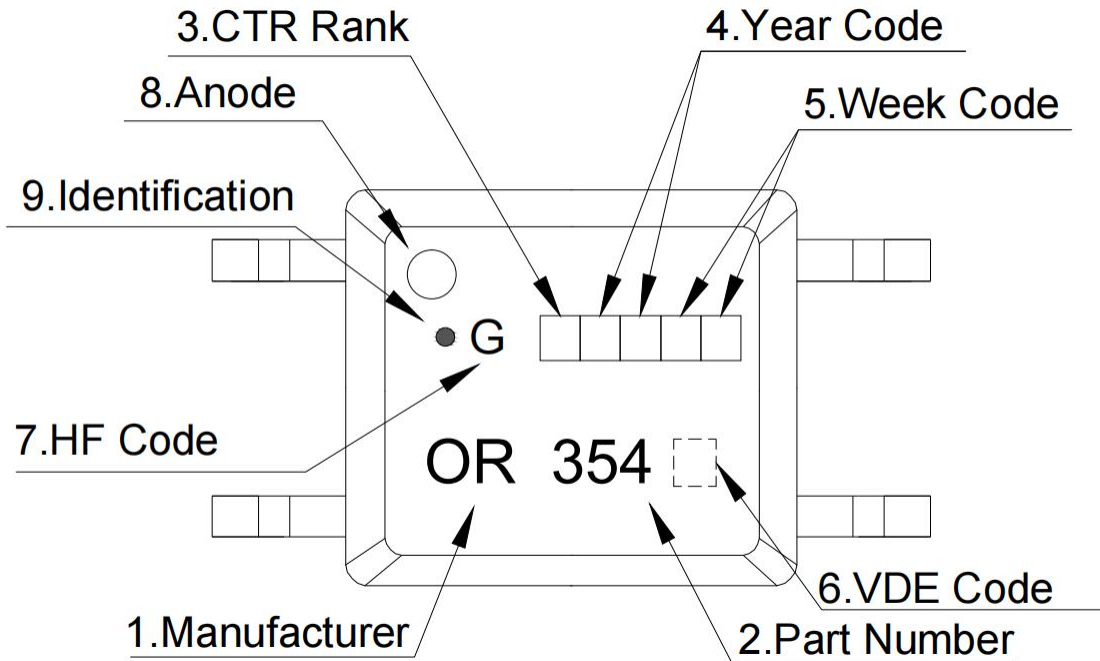

1. Manufacturer : ORIENT.
2. Part Number : 354.
3. Rank Code : CTR Rank
4. Year Code  : '0' means '2020' and so on.
5. Week Code : 01 means the first week, 02 means the second week and so on.
6. VDE Code . (Optional)
7. HF Code 'G': Halogen Free.
8. Anode.
9. Identification.

\* VDE Code can be selected.

### 10. Outer Dimension

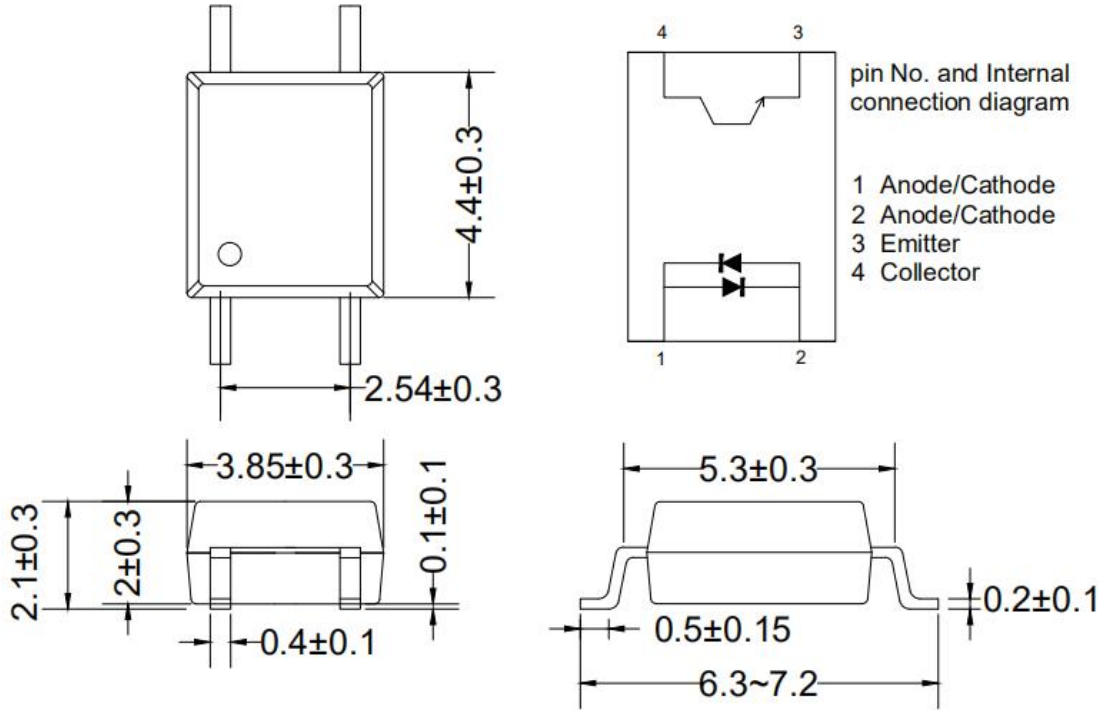

### 11. Recommended Foot Print Patterns (Mount Pad)

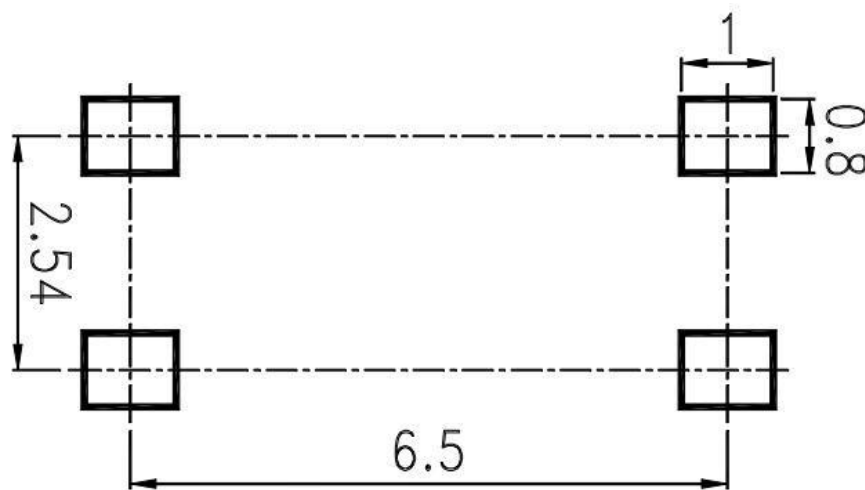

unit: mm

## 12. Taping Dimensions

### (1) OR-354-TP

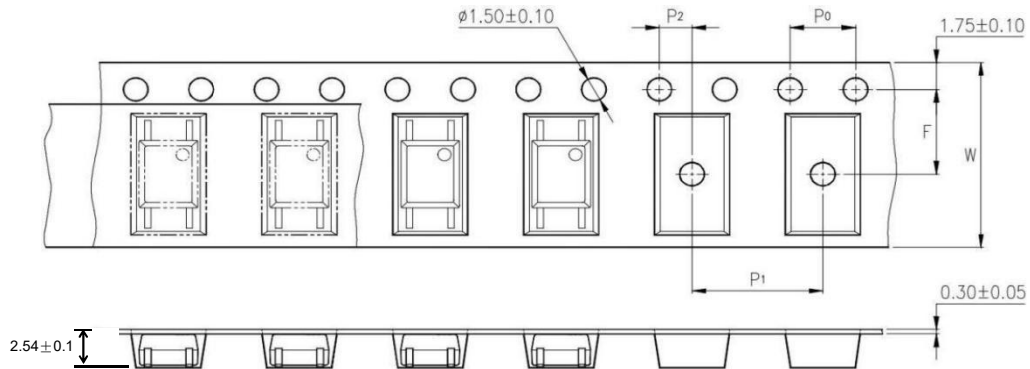

### (2) OR-354-TP1

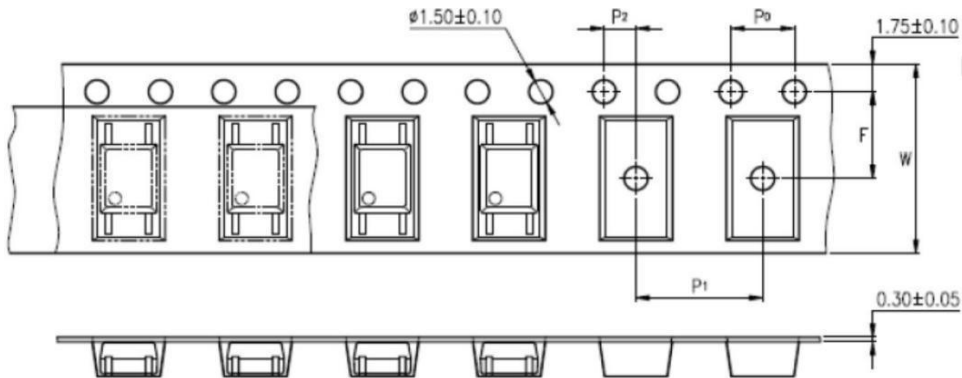

Description	Symbol	Dimension in mm(inch)
Tape wide	W	12±0.3 (0.472)
Pitch of sprocket holes	P0	4±0.1 (0.157)
Distance of compartment	F	5.5±0.1 (0.217)
	P2	2±0.1 (0.079)
Distance of compartment to compartment	P1	8±0.1 (0.315)

Package Type	TP/TP1
Quantities(pcs)	3000

### 13. Package Dimension

#### (1) package dimension

Packing Information	
Packing type	Reel type
Tape Width	12mm
Qty per Reel	3,000pcs
Small box (inner) Dimension	345*345*45mm
Large box (Outer) Dimension	480x360x360mm
Max qty per small box	6,000pcs
Max qty per large box	60,000pcs

#### (2)Packing Label Sample

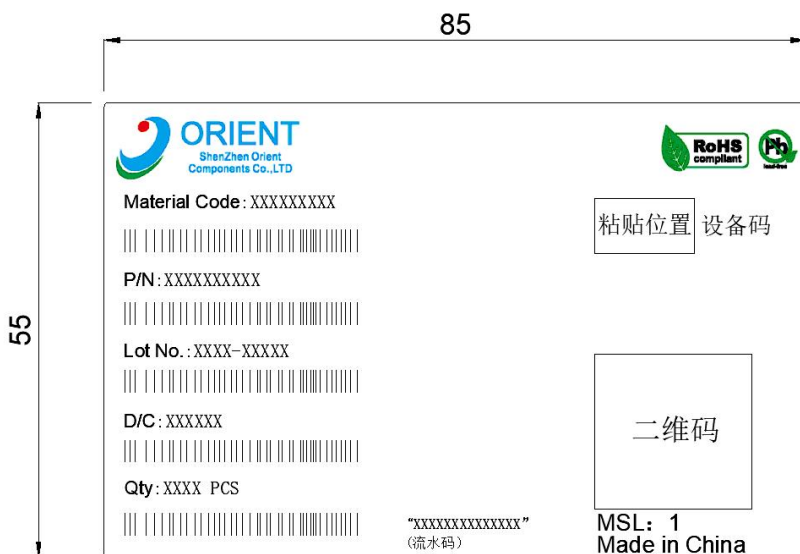

**Note:**

1. Material Code :Product ID.
2. P/N :Contents with "Order Information" in the specification.
3. Lot No. :Product weeks.
4. D/C :Product data.
5. Quantity :Packaging quantity.

### 14. Temperature Profile Of Soldering

(1) IR Reflow soldering (JEDEC-STD-020 compliant)

One time soldering reflow is recommended within the condition of temperature and time profile shown below. Do not solder more than three times.

Profile item	Conditions
Preheat	
- Temperature Min (T Smin )	150°C
- Temperature Max (T Smax )	200°C
- Time (min to max) (ts)	90±30 sec
Soldering zone	
- Temperature (TL )	217°C
- Time (t L )	60 sec
Peak Temperature	260°C
Peak Temperature time	20 sec
Ramp-up rate	3°C / sec max.
Ramp-down rate from peak temperature	3~6°C / sec
Reflow times	≤3

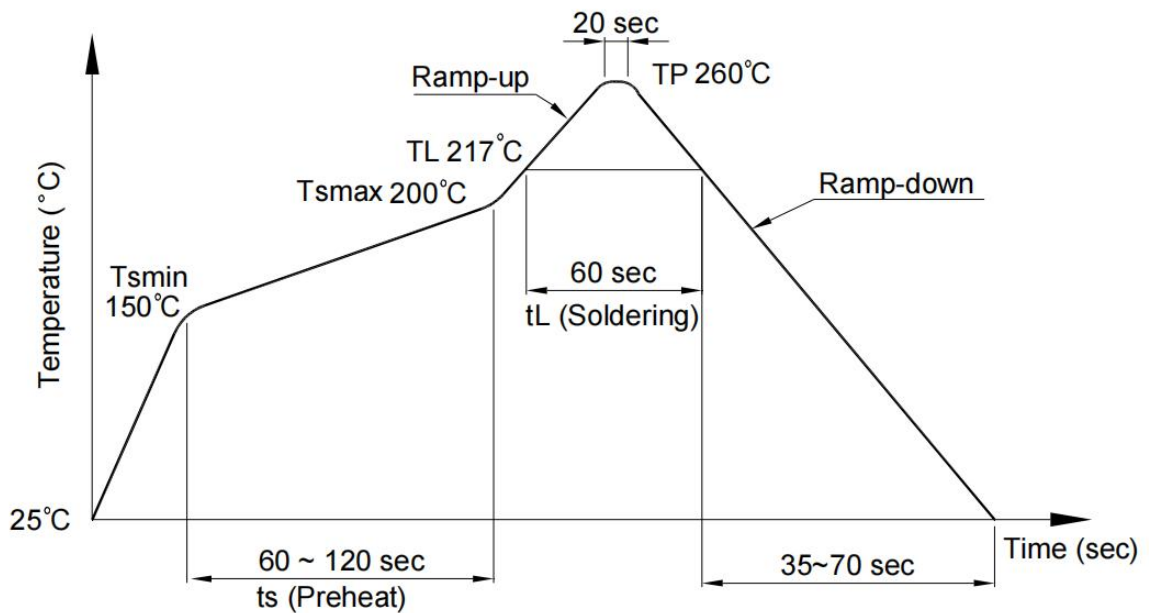

(2) Wave soldering (JEDEC22 A111 compliant)

One time soldering is recommended within the condition of temperature.

Temperature	260+0/-5°C
Time	10 sec
Preheat temperature	25 to 140°C
Preheat time	30 to 80 sec

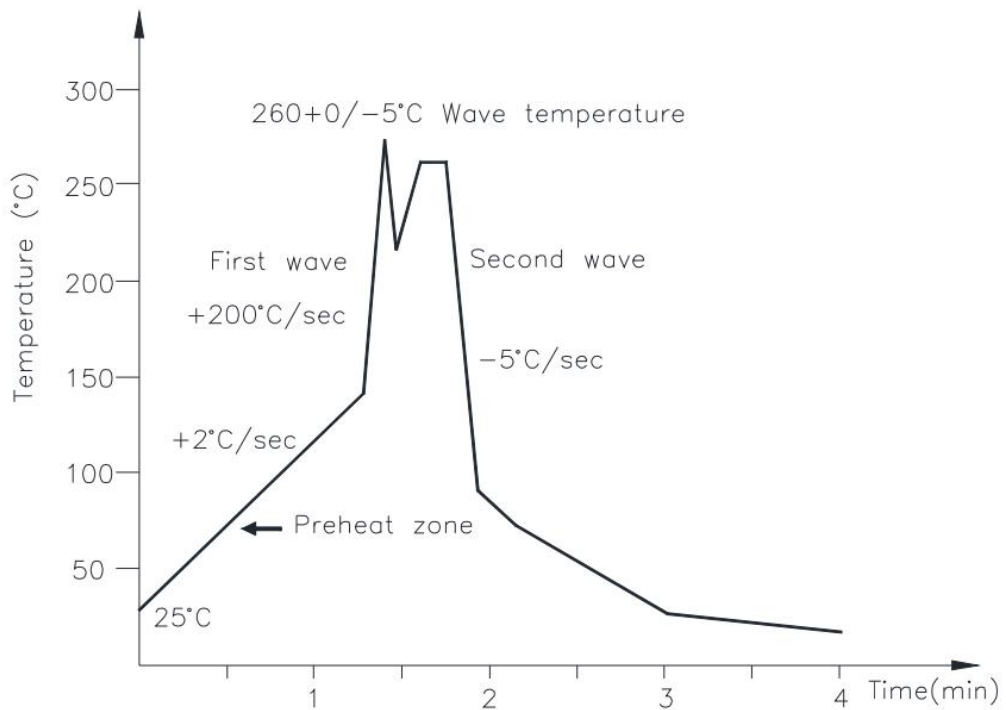

(3) Hand soldering by soldering iron

Allow single lead soldering in every single process. One time soldering is recommended.

Temperature	380+0/-5°C
Time	3 sec max

### 15. Characteristics Curve

Fig.1 Forward current vs Ambient temperature

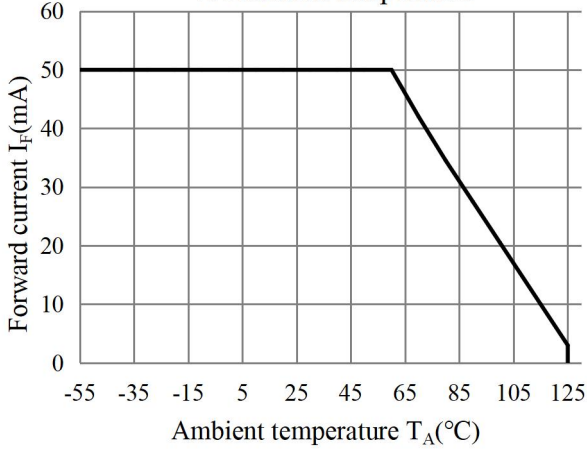

Fig.2 Collector Power Dissipation vs. Ambient temperature

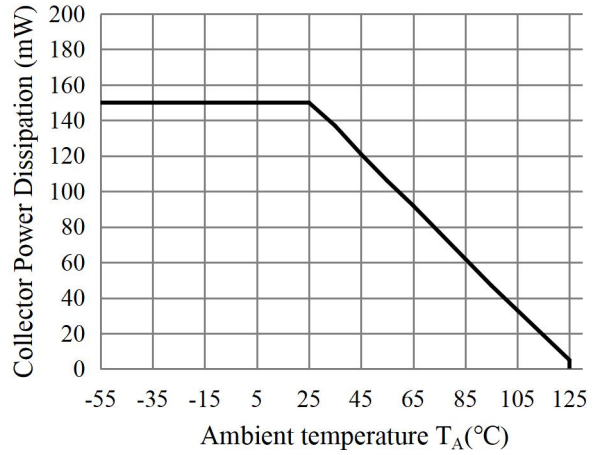

Fig.3 Forward Current vs. Forward Voltage

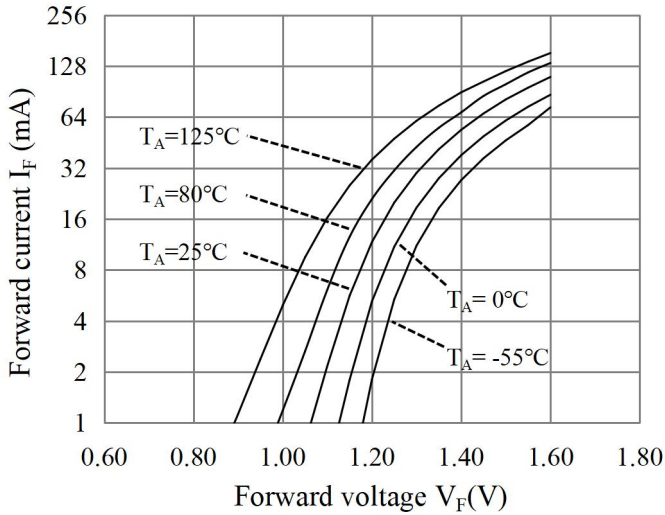

Fig.4 Collector-emitter Saturation Voltage vs. Forward Current

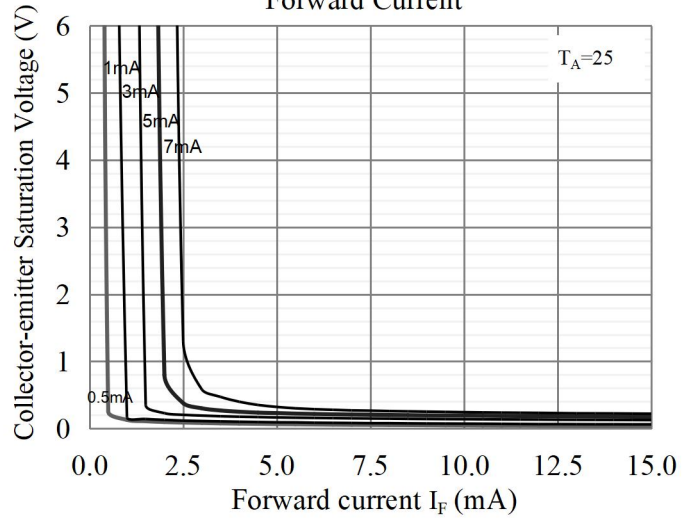

fig.5 Collector Current vs. Non-Saturated Collector Emitter Voltage

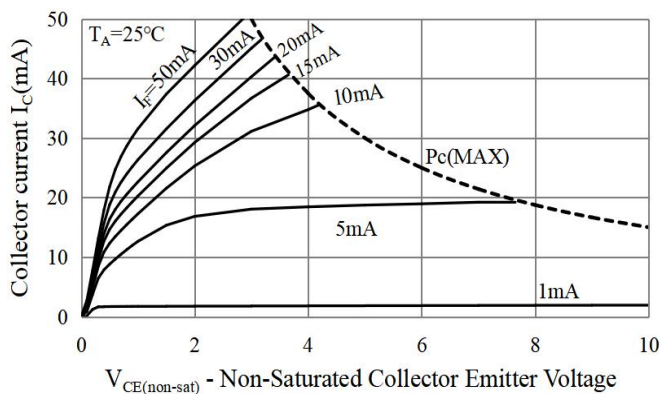

fig.6 Collector Current vs. Non-Saturated Collector Emitter Voltage

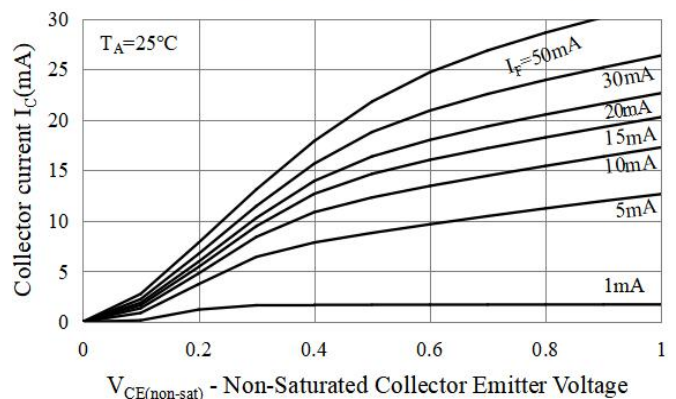

Fig.7 Relative Current Transfer Ratio vs. Ambient Temperature

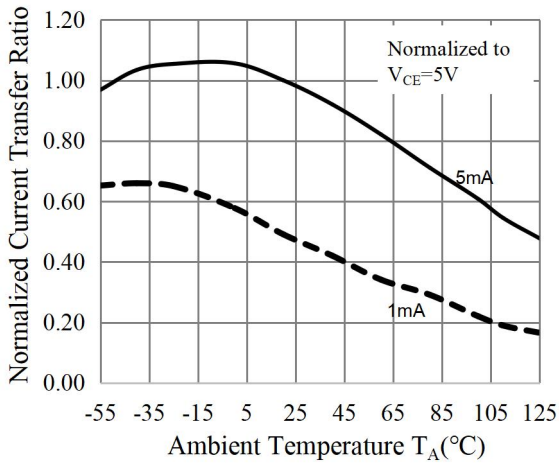

Fig.8 Relative Current Transfer Ratio vs. Ambient Temperature

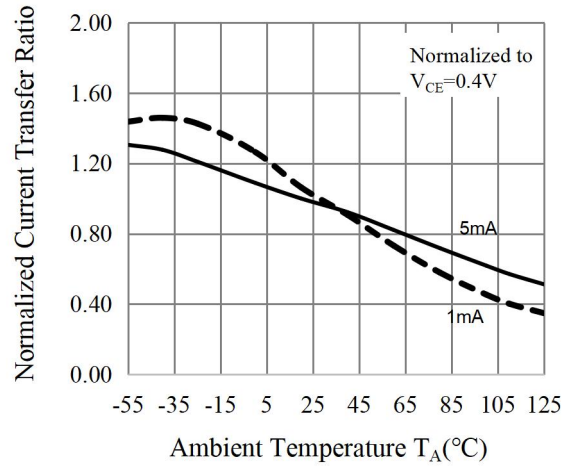

Fig.9 Forward Current vs. Current Transfer Ratio

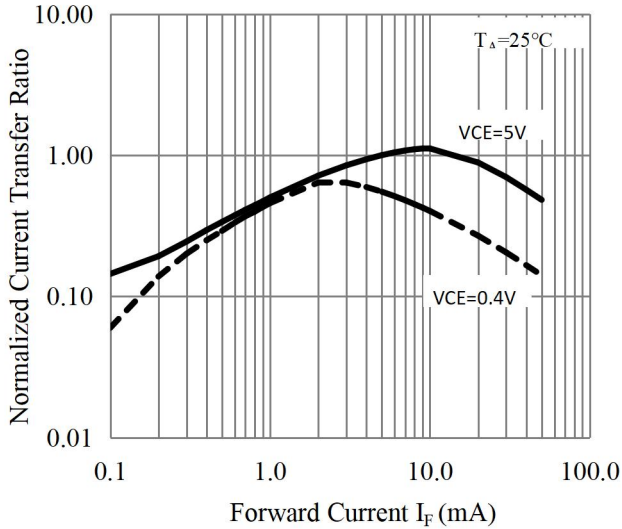

Fig.10 Collector Dark Current vs. Ambient Temperature

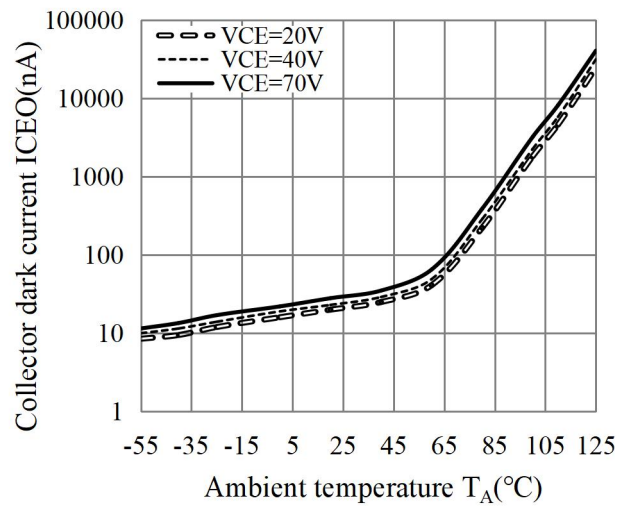

Fig.11 Collector-emitter Saturation Voltage vs. Ambient Temperature

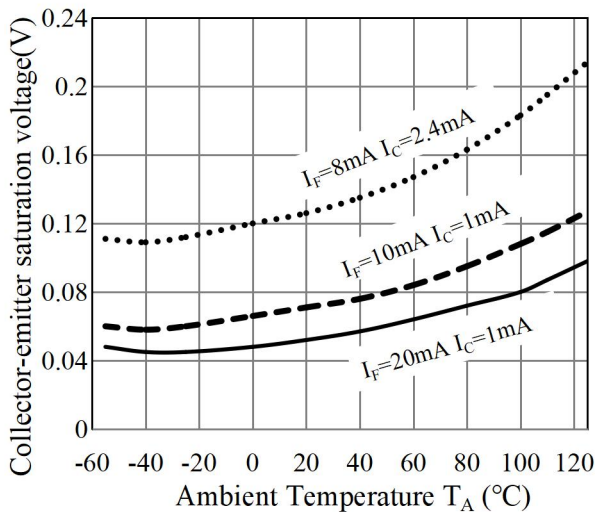

Fig.12 Switching Time vs. Load Resistance

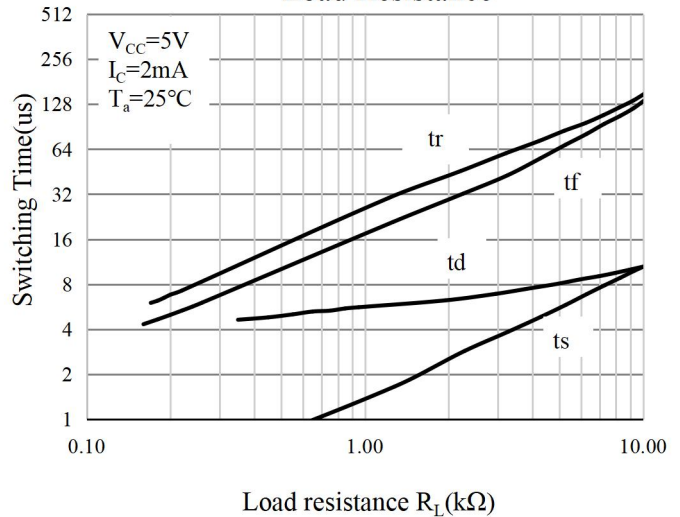

Fig.13 Respnse Time vs. Ambient temperature

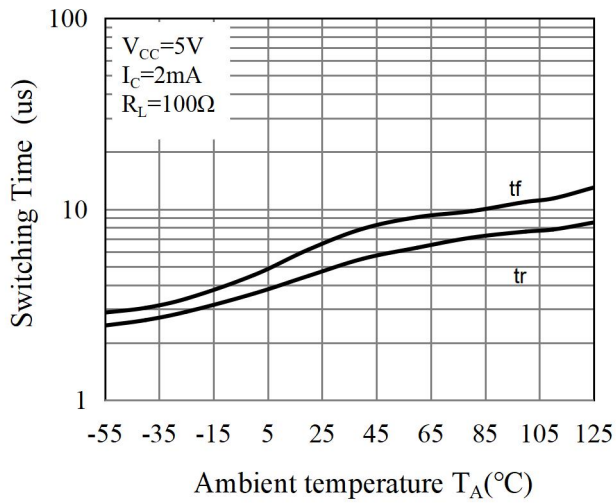
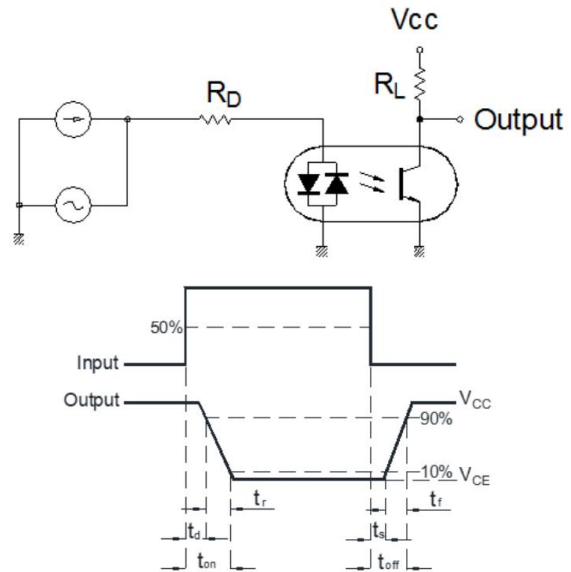

Fig.14 Switching Time Test Circuit & Waveforms



## 16. NOTES

1. Orient is continually improving the quality, reliability, function or design and Orient reserves the right to make changes without further notices.
2. The products shown in this publication are designed for the general use in electronic applications such as office automation equipment, communications devices, audio/visual equipment, electrical application and instrumentation.
3. For equipment/devices where high reliability or safety is required, such as space applications, nuclear power control equipment, medical equipment, etc, please contact our sales representatives.
4. When requiring a device for any "specific" application, please contact our sales in advice.
5. If there are any questions about the contents of this publication, please contact us at your convenience.
6. The contents described herein are subject to change without prior notice.
7. Immerge unit's body in solder paste is not recommended.