



# ORIENT

## Photo coupler

### Product Data Sheet

Part Number: OR-X223

Customer: \_\_\_\_\_

Date: \_\_\_\_\_

**SHENZHEN ORIENT COMPONENTS CO., LTD**

Block A 3rd Floor No.4 Building, Tian'an Cyber Park, Huangge Rd, LongGang Dist, Shenzhen, GD

TEL: 0755-29681816

FAX: 0755-29681200

[www.orient-opto.com](http://www.orient-opto.com)

### 1. Features

- (1) Low trigger current IFT 10mA .
- (2) Repetitive peak OFF-state voltage 800V .
- (3) Load current 0.3A, 0.6A, 0.9A or 1.2A .
- (4) Wide operating temperature range of -55°C to 85°C .
- (5) High isolation voltage between input and output (Viso=5000 Vrms).
- (6) Safety approval
  - UL approved (No.E323844)
  - VDE approved (No.40029733)
  - CQC approved (No.CQC19001231254 )
- (7) In compliance with RoHS, REACH standards.
- (8) MSL Class I

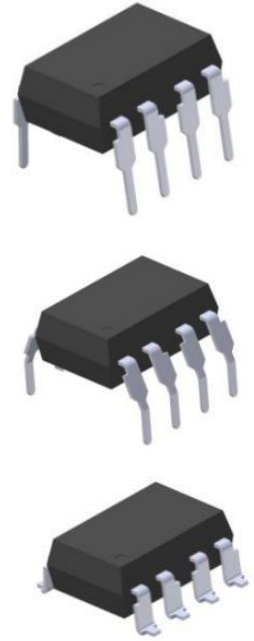

### 2. Instructions

The OR-X223 series of devices are each consist of a GaAs infrared emitting diode optically coupled to a monolithic silicon random phase photo triac and a main output triac. They are designed for interfacing between electronic controls and loads to control inductive for 115 to 240 VAC operations. They are packaged in 8pin DIP package and available in surface mount SMD option.

### 3. Application Range

- Home appliances
- Industrial equipment
- Switching motors, fans, heaters, solenoids and valces.
- Power control such as lighting and temperature control

### 4. Functional Diagram

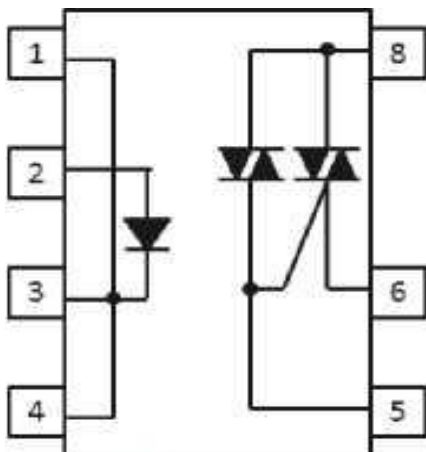

LED Anode	2
LED Cathode	1,3,4
Triac Gate	5
Triac T1	6
Triac T2	8

## 5. Absolute Maximum Ratings (Ta=25°C)

Parameter		Symbol	Rated Value	Unit	
Input	Forward Current	$I_F$	60	mA	
	Peak Forward Current *1	$I_{FP}$	1	A	
	Reverse Voltage	$V_R$	6	V	
Output	Repetitive peak OFF-state Voltage		$V_{DRM}$	800	V
	On state RMS current	OR-0223	$I_{T(RMS)}$	0.3	A
		OR-1223		0.6	
		OR-2223		0.9	
		OR-3223		1.2	
	*3 Peak Repetitive Surge Current	OR-0223	$I_{TSM}$	3	A
		OR-1223		6	
		OR-2223		9	
		OR-3223		12	
	Junction Temperature		$T_J$	125	°C
Insulation Voltage *4		$V_{iso}$	5000	Vrms	
Working Temperature		$T_{opr}$	-55 ~ + 85	°C	
Deposit Temperature		$T_{stg}$	-55 ~ + 125		
Soldering Temperature		$T_{sol}$	260		

Notes:

\*1  $f=100\text{Hz}$ , Duty Cycle = 0.1%

\*2 Sine wave, 50 to 60Hz, IFT=0mA.

\*3  $f=60\text{Hz}$ , one cycle.

\*4 AC for 1 minute, R.H.= 40 ~ 60% R.H. In this test, pins 1, 2, 3, 4 are shorted together, and pins 5, 6, 7, 8 are shorted together.

\*5 For 10 seconds

## 6. Recommended Operating Conditions

Parameter		Symbol	Min	Typ.*	Max	Unit	Condition
Input	Forward Voltage	$V_F$	---	1.2	1.4	V	$I_F=20\text{mA}$
	Reverse Current	$I_R$	---	---	5	$\mu\text{A}$	$V_R=6\text{V}$
Output	*1.Peak Blocking Current, Either Direction	$I_{DRM}$	---	10	100	$\mu\text{A}$	$V_{DRM}=800\text{V}$
	Peak On-State Voltage, Either Direction	$V_{TM}$	---	----	2.5	V	$I_F=10\text{mA}$ , $I_{TM}=\text{MAX}$
	Holding Current, Either Direction	$I_H$	---	---	25	mA	
	*2.Critical rate of Rise of Off-State Voltage	$dv/dt$	200	---	---	V/ $\mu\text{s}$	$V_{DRM}=800\text{V} \cdot 1/\sqrt{2}$
Transfer Characteristics	*3.Led Trigger Current, Current Required to Latch Output, Either Direction	$I_{FT}$	---	---	10	mA	$V_D=6\text{V}, R_L=100\Omega$
	Turn On Time	$T_{on}$	---	---	10	$\mu\text{s}$	$I_F = 20 \text{ mA}$ , $V_D = 6\text{V}$ , $R_L = 100\Omega$
	Isolation Resistance	$R_{I-O}$	$5 \times 10^{11}$	$10^{12}$	---	$\Omega$	$V_{I-O}=500\text{V DC}$ , 40 to 60%RH

## 7. Order Information

### Part Number

**OR-X223U-Y-Z**

### Note

X223 = Part Number, 0223 , 1223 , 2223 or 3223 .

U = Lead form option (S, M or none)

Y = Tape and reel option ( TA,TA1 or none).

Z = 'V' code for VDE safety (This options is not necessary).

\* VDE Code can be selected.

Option	Description	Packing quantity
None	Standard DIP Option	45 units per tube
M	Wide lead bend (0.4 inch spacing)	45 units per tube
TA	Surface mount lead form (low profile) + TA tape & reel option	1000 units per reel
TA1	Surface mount lead form (low profile) + TA1 tape & reel option	1000 units per reel

## 8. Naming Rule

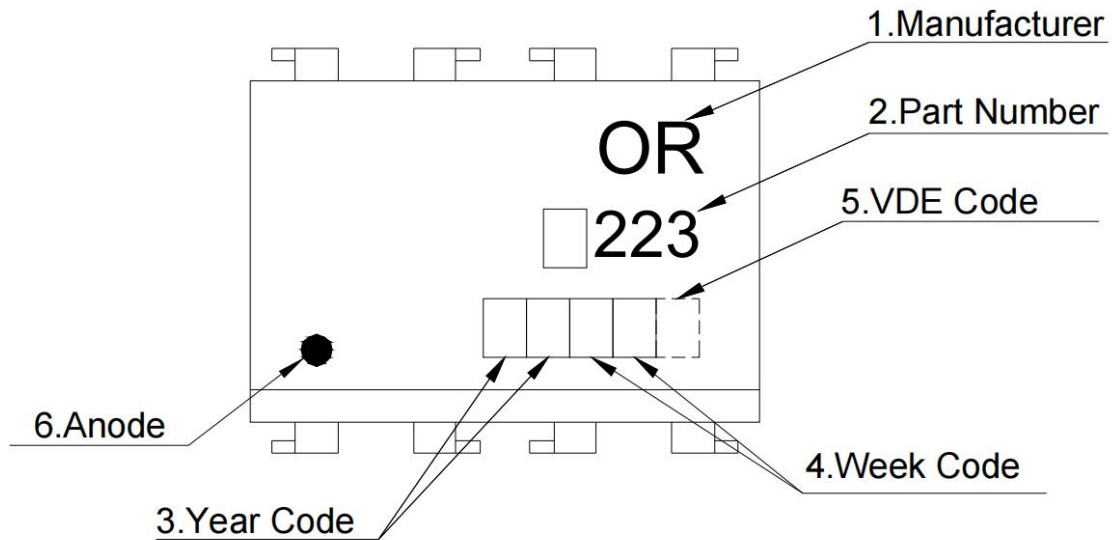

1. Manufacturer : ORIENT.
2. Part Number : 0223, 1223, 2223 or 3223 .
3. Year Code  : '21' means '2021' and so on.
4. Week Code : 01 means the first week, 02 means the second week and so on.
5. VDE Code . (Optional)
6. Anode.

\* VDE Code can be selected.

## 9. Outer Dimension

### (1) OR-X223

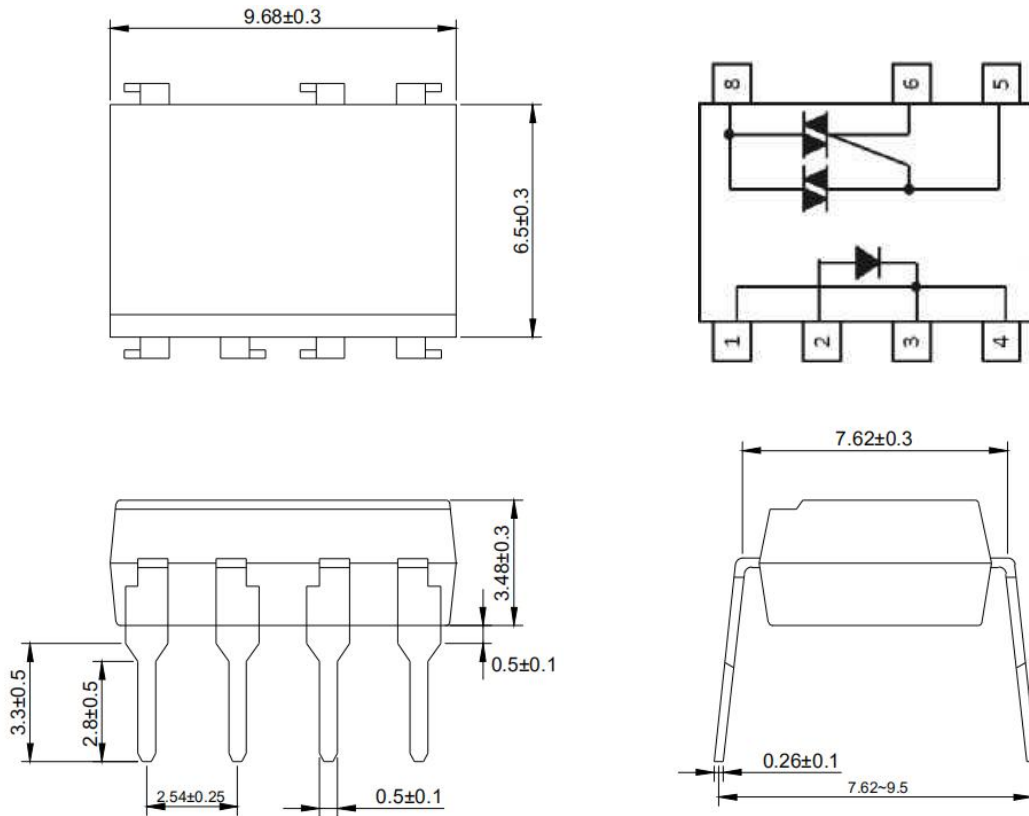

### (2) OR-X223M

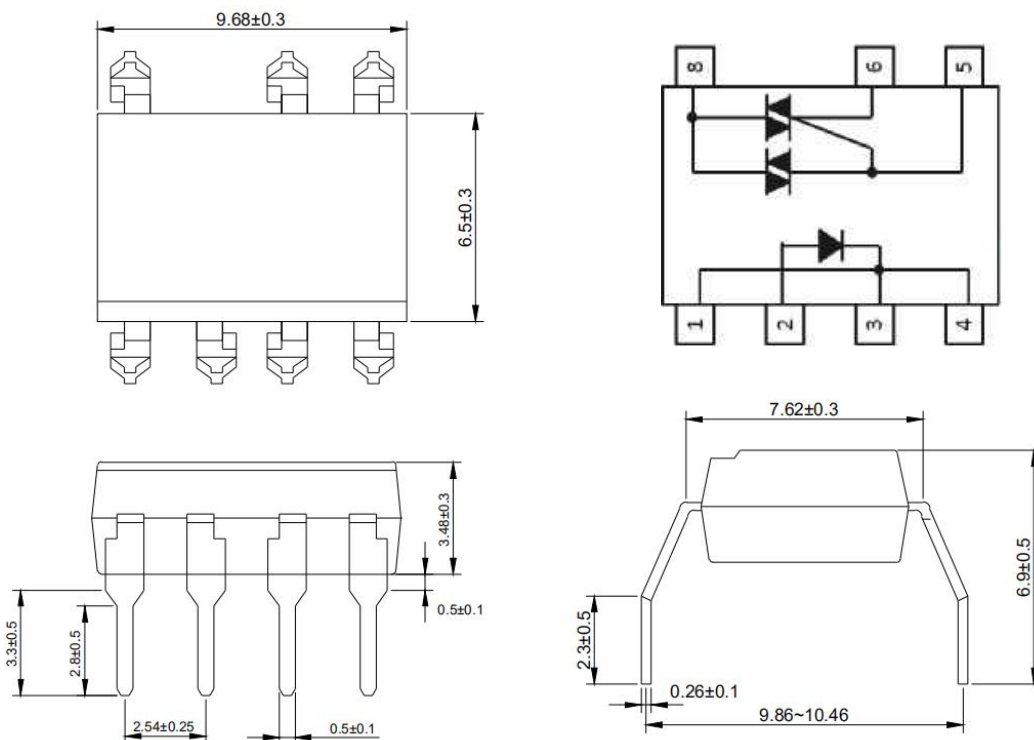

(3) OR-X223S

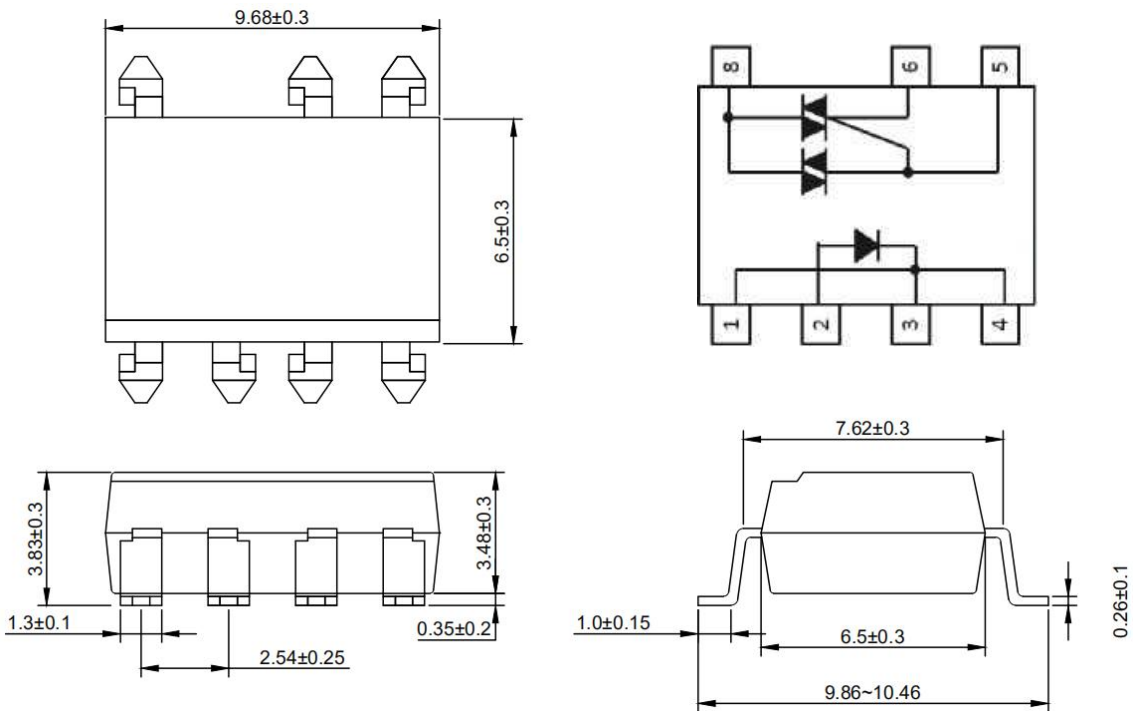

12、 Recommended Foot Print Patterns (Mount Pad)

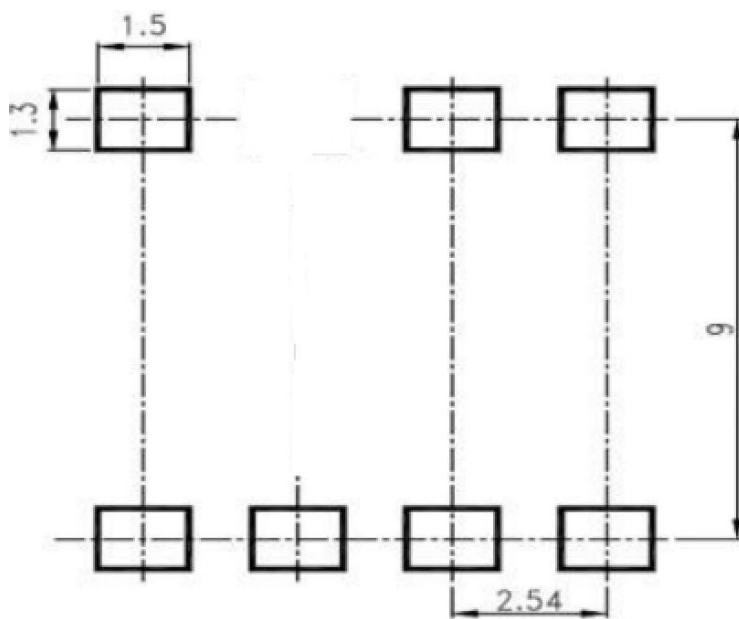

unit: mm



## 10. Taping Dimensions

### (1) OR-X223-TA

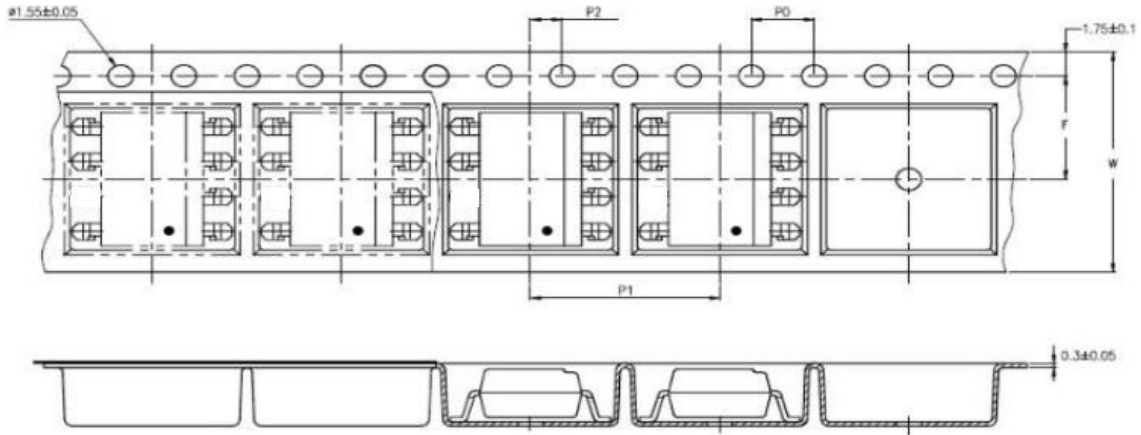

### (2) OR-X223-TA1

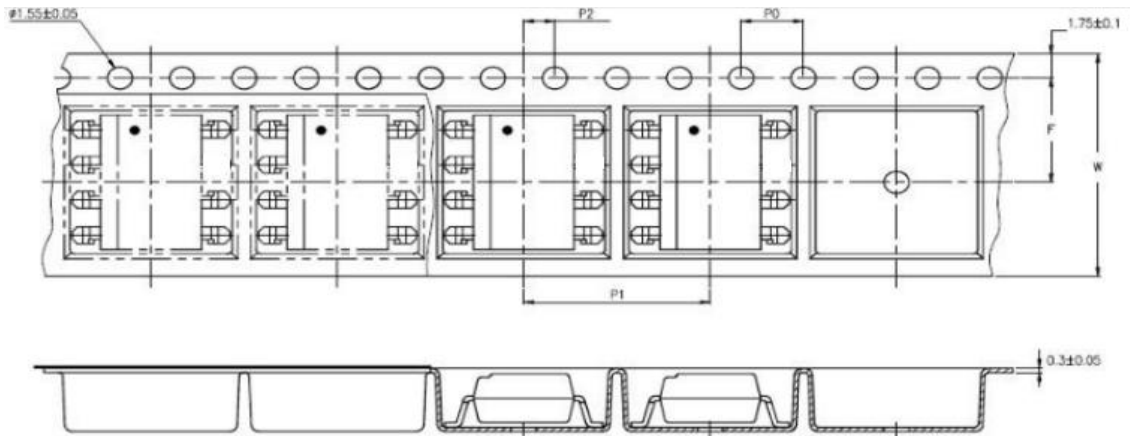

type	symbol	Size: mm ( inches )
bandwidth	W	16±0.3 (0.63)
pitch	P0	4±0.1 (0.15)
pitch	F	7.5±0.1 (0.295)
	P2	2±0.1 (0.079)
interval	P1	12±0.1 (0.472)

Encapsulation type	TA/TA1
amount (pcs)	1000

## 11. Package Dimension

### (1) package dimension





DIP Type

Packing Information	
Packing type	Tube
Qty per Tube	45pcs
Small box (Inner) Dimension	525*128*60mm
Large box (Outer) Dimension	545*290*335mm
The Amount per Inner Box	2,250pcs
The Amount per Outer Box	22,500pcs

SOP Type

Packing Information	
Packing type	Reel type
Tape Width	16mm
Qty per Reel	1,000pcs
Small box (inner) Dimension	345*345*58.5mm
Large box (Outer) Dimension	620x360x360mm
Max qty per small box	2,000pcs
Max qty per large box	20,000pcs

### (2)Packing Label Sample

 <p>Material Code : 120PCXXXXXX          P/N : OR-XXXXXX          Lot No. : XXXXXX-XXXXX-TX-X          D/C : XXXX          Qty : XXXX PCS</p>	  
<div style="display: flex; justify-content: space-around;"> <div style="border: 1px solid black; padding: 5px; width: 40%;">内箱码</div> <div style="border: 1px solid black; padding: 5px; width: 40%;">外箱码</div> </div> <p>“XXXXXXXXXXXXXXXX” (一体机序列码)  <b>Made in China</b></p>	

**Note:**

1. Material Code :Product ID.
2. P/N :Contents with "Order Information" in the specification.
3. Lot No. :Product data.
4. D/C :Product weeks.
5. Quantity :Packaging quantity.

## 12. Temperature Profile Of Soldering

(1) IR Reflow soldering (JEDEC-STD-020C compliant)

Note: one solder backflow is recommended under the conditions described below in the temperature and time profile. Do not weld more than three times.

Profile item	Conditions
Preheat	
- Temperature Min (T Smin )	150°C
- Temperature Max (T Smax )	200°C
- Time (min to max) (ts)	90±30 sec
Soldering zone	
- Temperature (TL )	217°C
- Time (t L )	60 sec
Peak Temperature	260°C
Peak Temperature time	20 sec
Ramp-up rate	3°C / sec max.
Ramp-down rate from peak temperature	3~6°C / sec
Reflow times	≤3

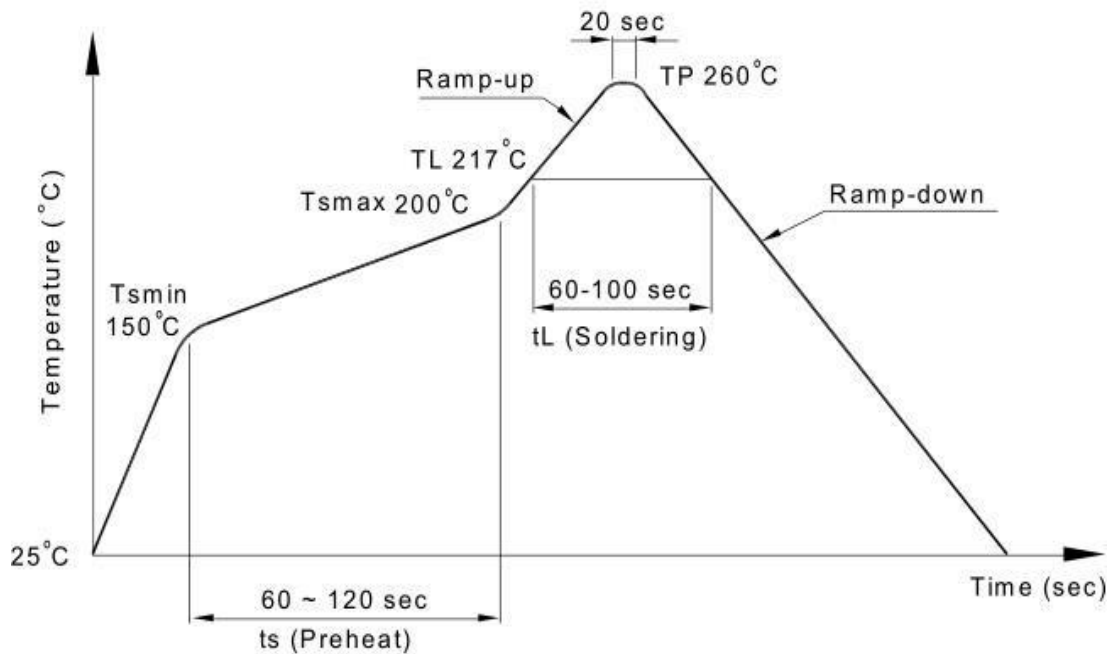

(2) Wave soldering (JEDEC22A111 compliant)

One-time welding is recommended under the temperature condition.

Temperature	260+0/-5°C
Time	10 sec
Preheat temperature	5 to 140°C
Preheat time	30 to 80 sec

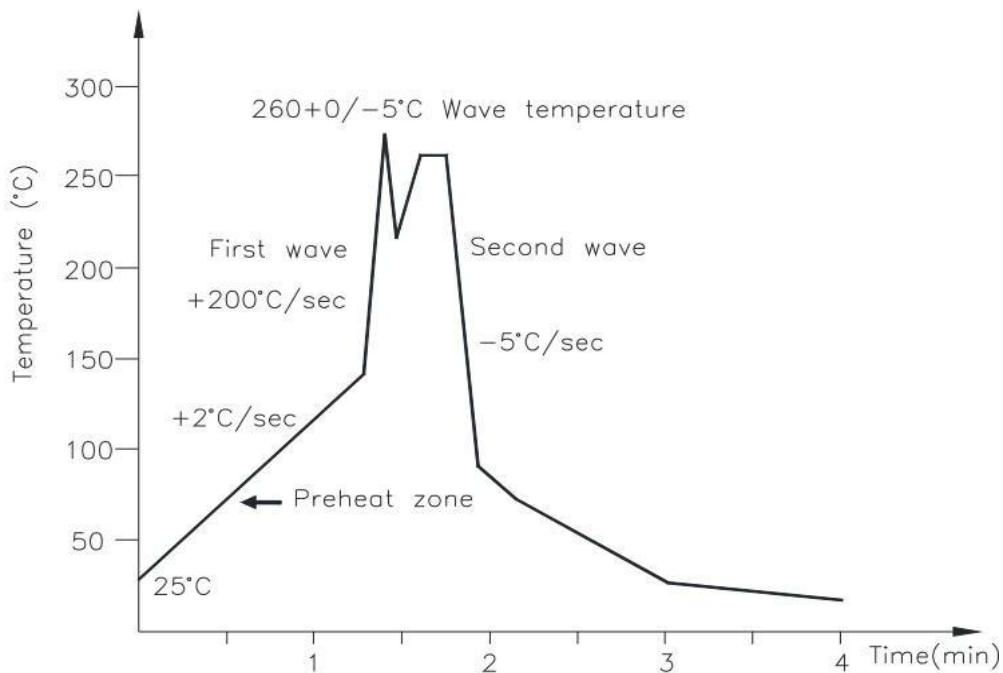

(3) Hand soldering by soldering iron

Single lead welding is allowed in each process and one-time welding is recommended.

Temperature	380+0/-5°C
Time	3 sec max

### 13. Characteristics Curve

Fig.1 ON-state Current vs. Ambient temperature

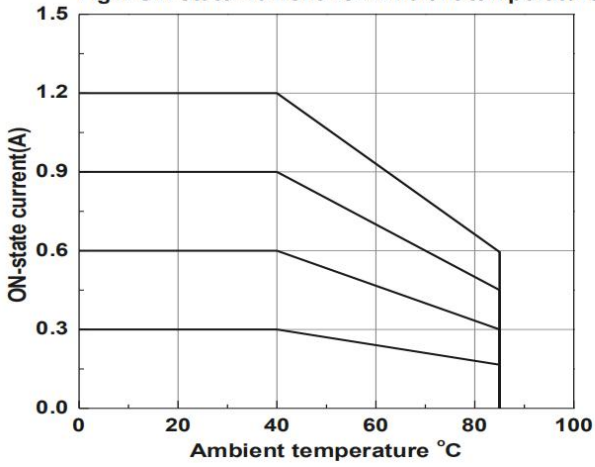

Figure 2. On Voltage vs Ambient Temperature

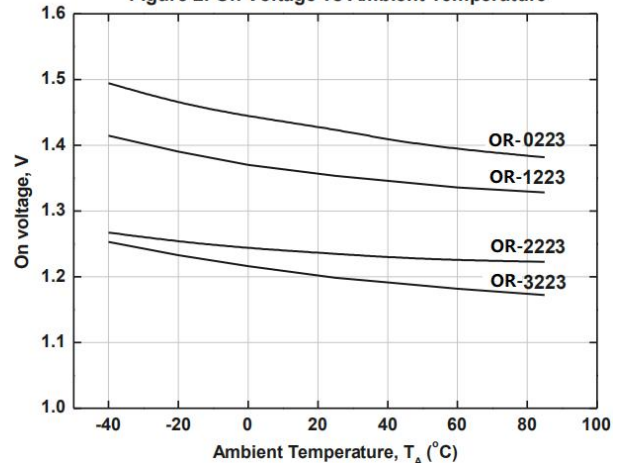

Figure 3. Trigger LED Current vs Ambient Temperature

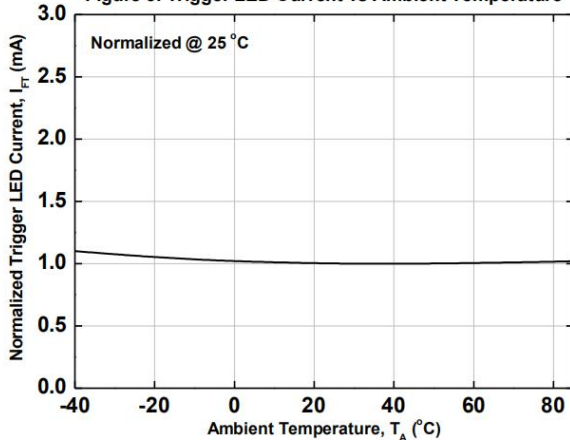

Figure 4. LED Dropout Voltage vs Ambient Temperature

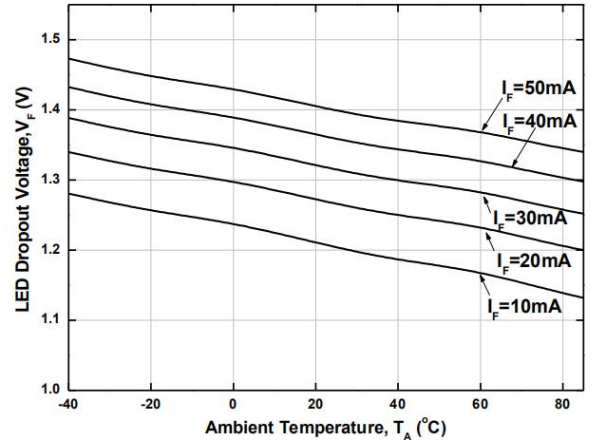

Figure 5. Turn on time vs LED current

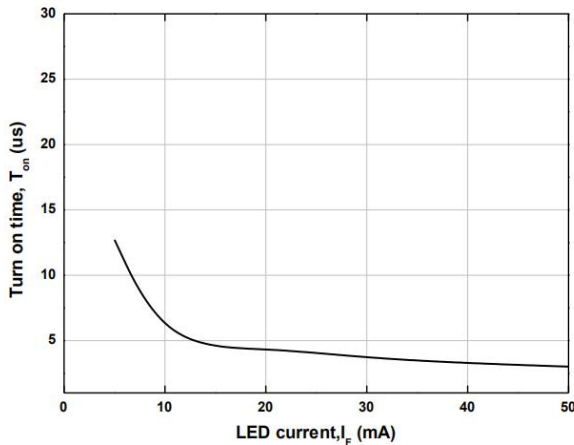

Figure 6. Off state leakage Current vs Load voltage

